

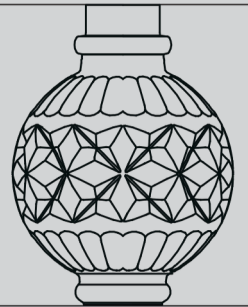

ASFOUR
CRYSTAL

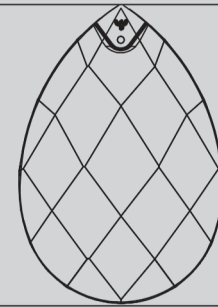

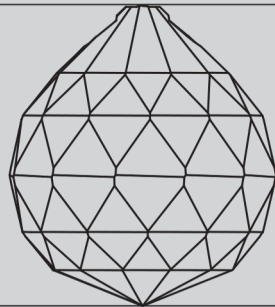
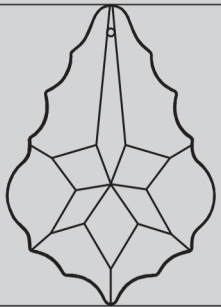

We invite you to discover
our leadership journey, guaranteeing to evoke
unique sentiments with each and every
shining piece.

**Welcome to world of
UNLIMITED POSSIBILITIES**

Introduction **Page**
2

Crystal Parts **Page**
20

Chandelier **Page**
Accessories **64**

The Crystal **Page**
Breeze **82**

Terms **Page**
And Conditions **106**

Packaging **Page**
Details **116**

UNLIMITED
POSSIBILITIES

**Boasting over 60 years of unmatched precision and attention to details,
Asfour Crystal has successfully managed to carve itself a competitive
niche through using the latest technology,
premium quality and craftsmanship and one-of-a-kind masterpieces
that have inspired not only crystal experts over decades
but also poets with a love for art.**

Waleed Asfour



60 years of shimmering achievements

Asfour Crystal's roots date back to 1961, originating in Egypt to lay a solid foundation for global success.

Marked by artistic heritage, as well as refined craftsmanship where every piece embodies a unique story.

Over the years, Asfour Crystal factory has witnessed the birth of aesthetic masterpieces while swiftly evolving to become the largest crystal manufacturer worldwide and leading presence in more than 70 countries around the globe.

A photograph of a glowing orange-red furnace opening. A glowing, faceted crystal is being pulled out by a rod. The scene is illuminated by the intense heat of the furnace, creating a warm, orange-red glow. The text "THE LARGEST MANUFACTURER OF CRYSTALS AROUND THE WORLD" is overlaid in the center of the image.

**THE LARGEST
MANUFACTURER OF
CRYSTALS AROUND
THE WORLD**

THE LARGEST CHANDELIER FACTORY IN MENA & AFRICA





70

COUNTRIES
AROUND THE WORLD

ASFOUR CRYSTAL INDUSTRIAL COMPLEX IS DIVIDED INTO FOUR MAIN SECTORS

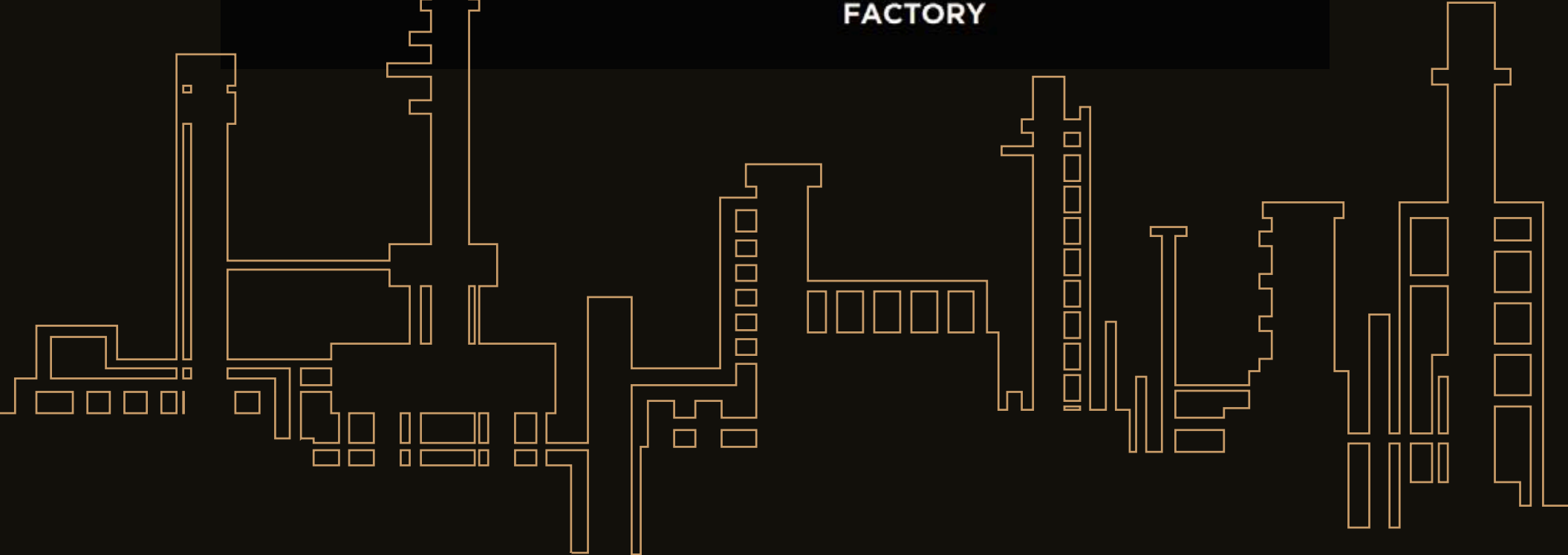



**Latest in technology
and magical hands are powered by
long years of experience**



WORLD-CLASS QUALITY

Asfour Crystal believes in the importance of competition, as well as the creation of a competitive edge that puts exceptional quality and added-value at the heart of its vision. Consequently, the company goes the extra mile to introduce world-class products that reflect utmost attention to details, in addition to unmatched precision across all stages of its operations; from choice of materials to timely delivery and seamless installation, guaranteeing a hassle-free experience for all clients where convenience comes first.



QUALITY AND CERTIFICATES

AN ICON OF EVERLASTING QUALITY

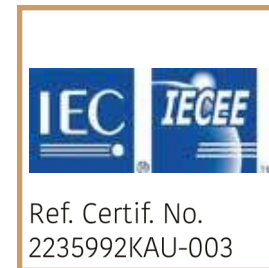

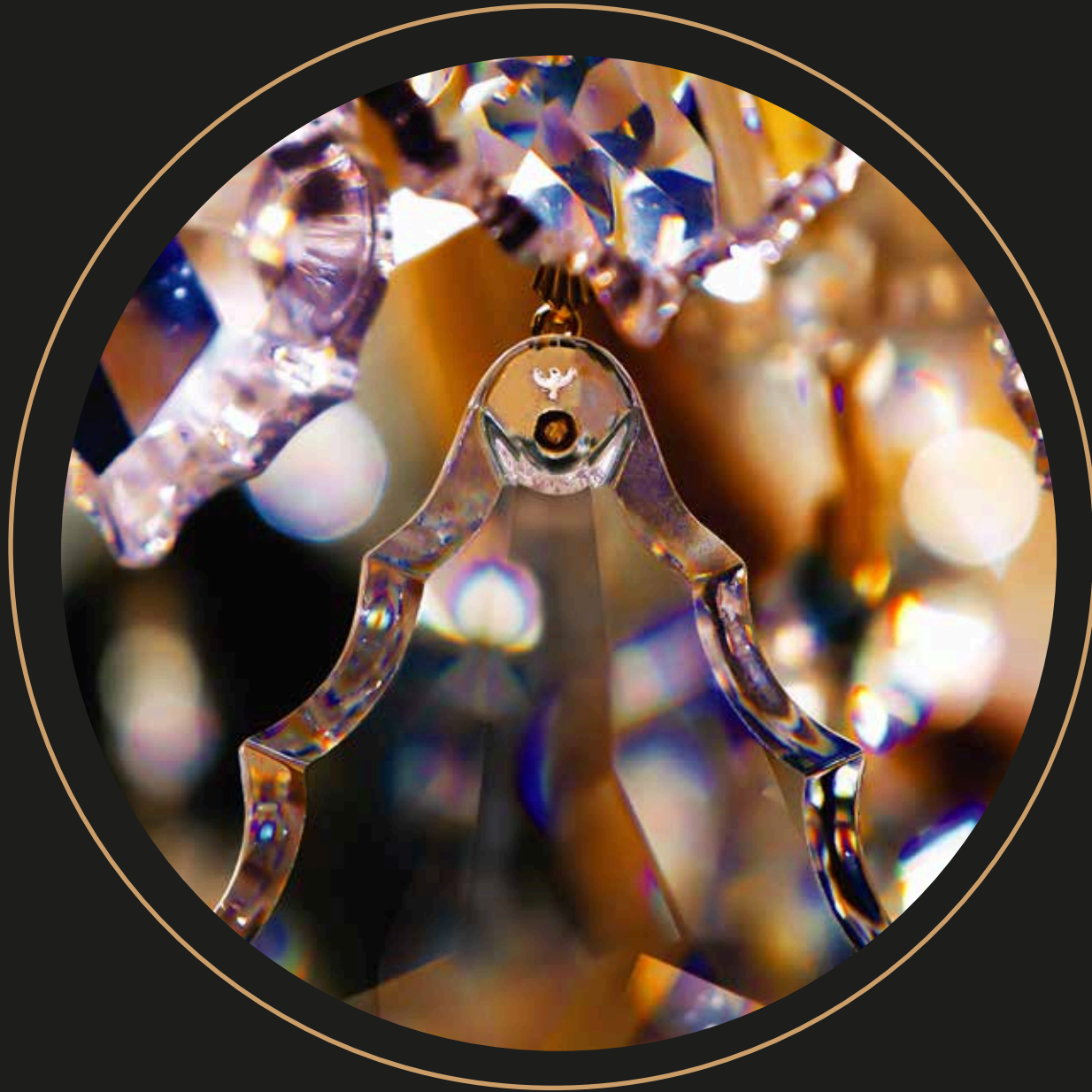

Asfour Crystal's Emblem is a Quality Trademark

Crowning an unparalleled precision and a lasting color luminosity.

TO MAKE SURE THAT EVERY CRYSTAL PART IS ORIGINAL

Look for the engraved emblem as shown.

The bird symbol is engraved on both transparent
and colored crystal parts of size 2 inches and above.

Reflections With No Limits

Each crafted piece at Asfour Crystal is an inspirational work of art, unfolding an admirable story of meticulous cuts, unpatrolled innovation of dazzling reflections not found elsewhere.

Reflecting the creativity that lies at the heart of Asfour Crystal's parts are available in a large variety of shapes, cuts, and sizes to suit a wide spectrum of requirements, tastes and incomparable reflective index.



Crystal Coating

Crystal reflects an inspirational and artistic creation that reveals a unique tale of dedication and unprecedented innovation, in addition to timeless luminosity that lasts a lifetime.
Our standard pieces are available in below colors :



CLEAR



**GOLDEN
SHADOW**



AB



HONEY



SATIN

Imagine no limits of coloring possibilities and contact our team for special orders

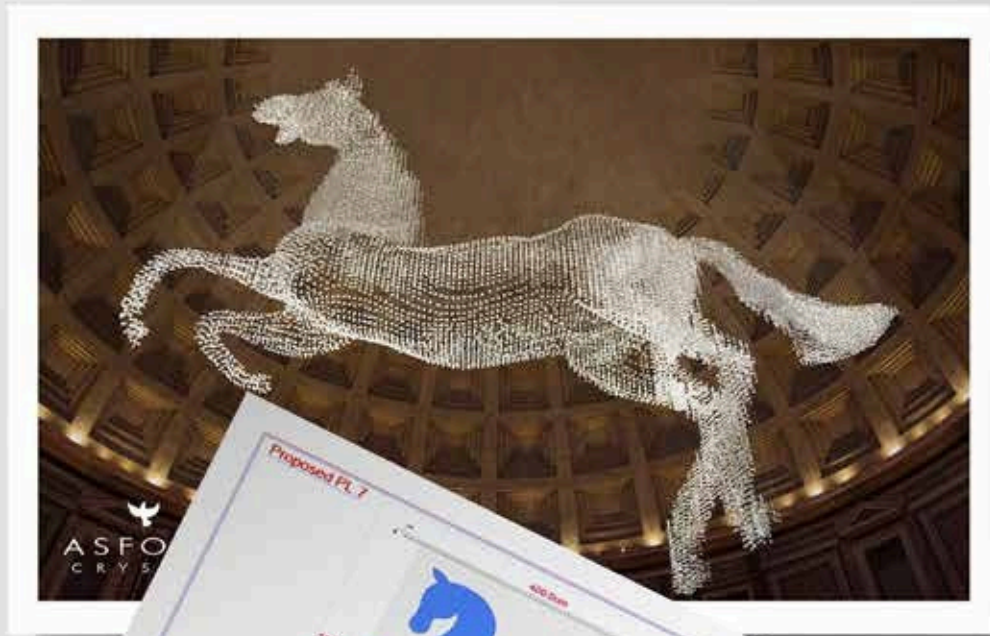

Proposed PL 7

400 Dims

300 Dims

100 Dims

ASFOUR CRYSTAL

Customer: ASFOUR CRYSTAL
Project: PL 7
Quote: 5000
 £ 500

Custom Design Specification

1 metre wide x 1.5m high x 100 mm depth
 Weight: 100 kg
 Notes: Suitable For Glass House at 200,000 ft

PHOTO 30

Detail 001

Reception G16

Material: Main entrance glass light details
 Size: 1000 x 1500 mm
 Weight: 100 kg
 Notes: Suitable For Glass House at 200,000 ft

ASFOUR CRYSTAL

Design & Install

Design By: [Signature]
 Checked By: [Signature]
 Approved By: [Signature]

DATE: 10/10/2023

INNOVATION UNLEASHED

Imagine transforming your ideas into a reality sanctuary of simply see the beauty of crystal reflection with its shimmering light come to life all around you thanks to glistening crystals that reflect magic in every moment. we transform dreams into a timeless and shining reality

Crystal Parts

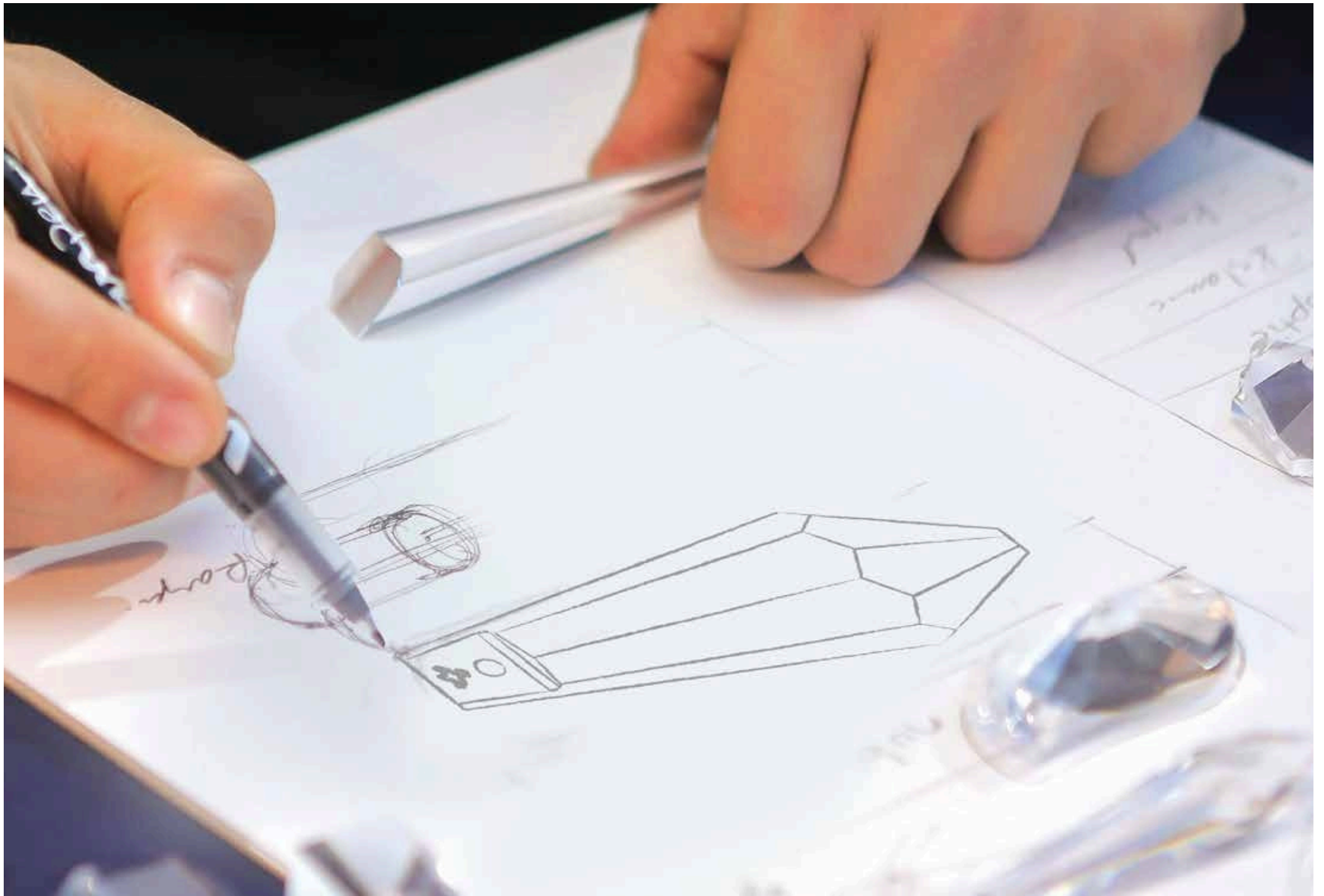

Octagon

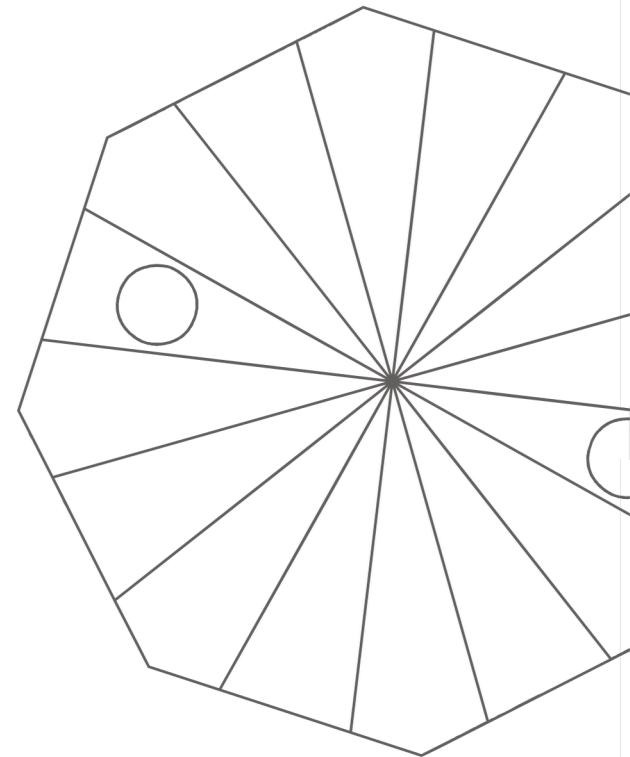
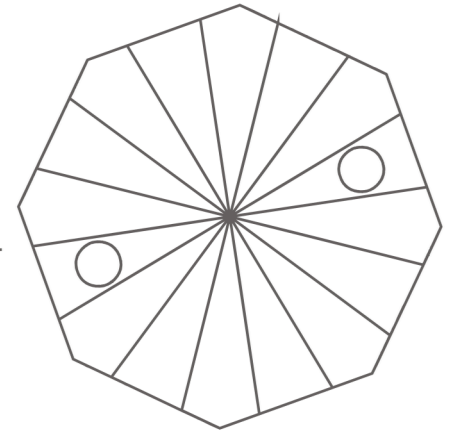



Octagon

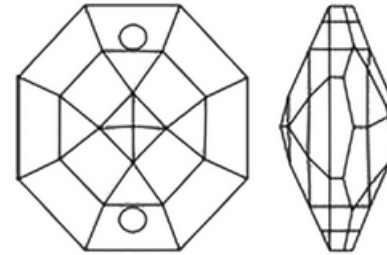

Model 1020

mm LxW

12|14|16|18|20|22|24|26|28|30|32|34|36|38|40|50

Color

All Colors

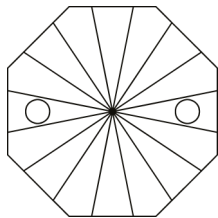
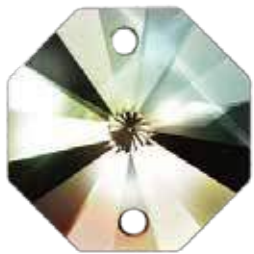

Model 1032

mm LxW
Colors

14

All colors

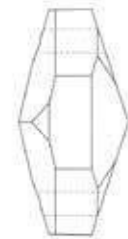
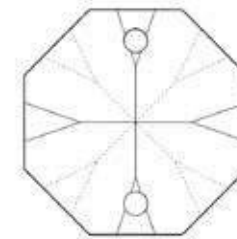

Model 1080

mm LxW
Color

12|14|16|18|20|22|24|26|28|30|32|34|36|38|40|50

All Colors



Octagon

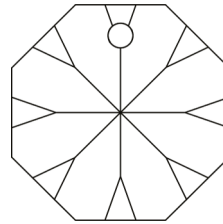
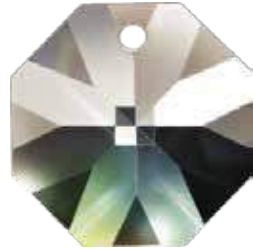

Model 1081

mm LxW
Colors

14
Clear

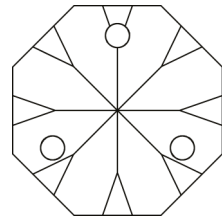

Model 1083

mm LxW 16|24
Color All Colors

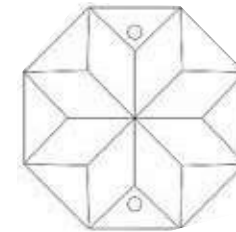

Model 1090

mm LxW 22|24
Color All Colors



Square

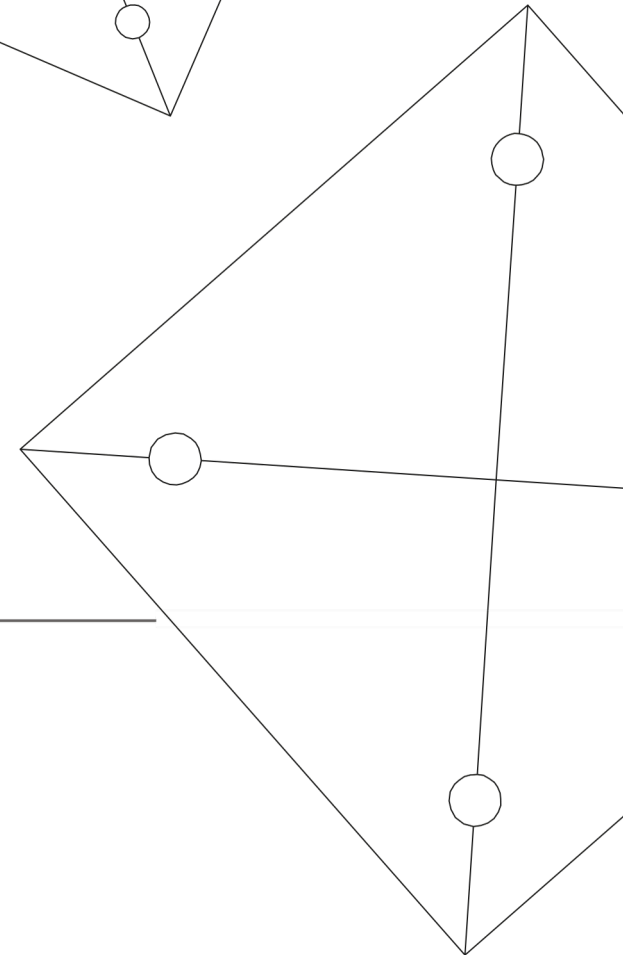
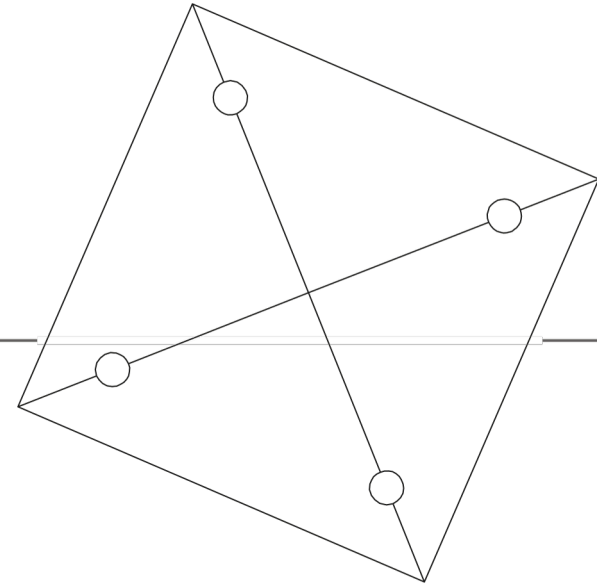



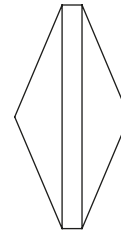
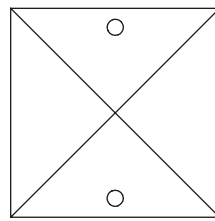

Model 2020

mm LxW
Colors

14	16	18	20	22	24	26	28
----	----	----	----	----	----	----	----

All colors



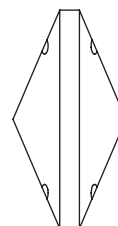
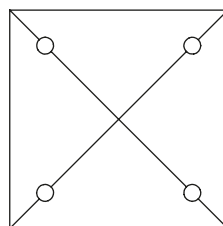

Model 2024

mm LxW
Colors

14	16	18	20	22	24	26	28
----	----	----	----	----	----	----	----

All colors



Round

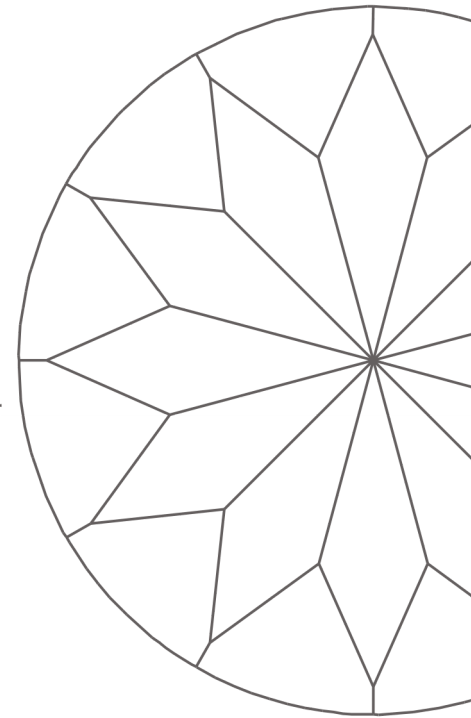
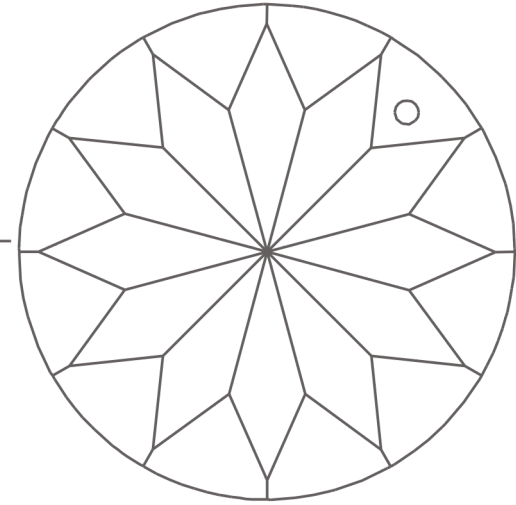



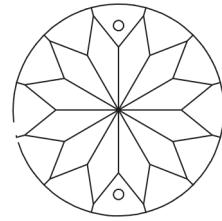

Model 1040

mm LxW
Colors

40/45
All Colors



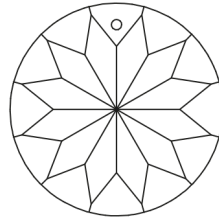

Model 1041

mm LxW

40/45

Color

All Colors



Pendeloqe

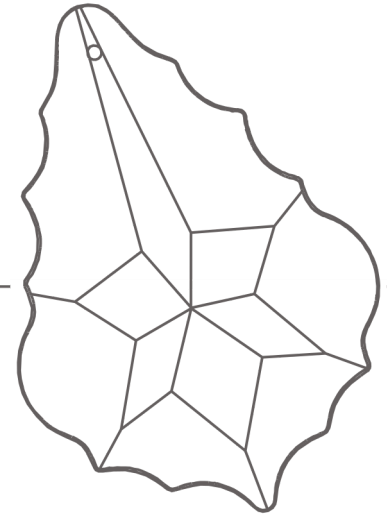



Pendeloque

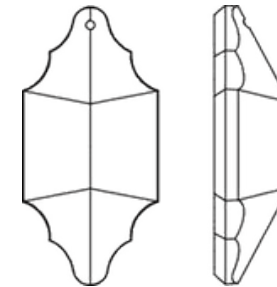
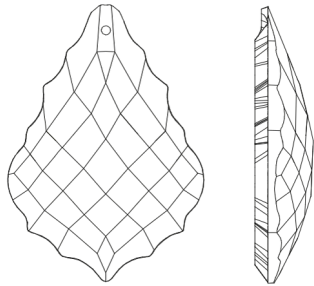

Model 910

Inch

2	2.5	3	3.5
---	-----	---	-----

mm LxW

50x35	62x43	75x53	89x62
-------	-------	-------	-------

Colors All colors

Model 914

Inch

2.5

mm LxW

64x30

Colors All colors

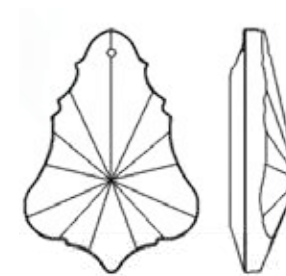
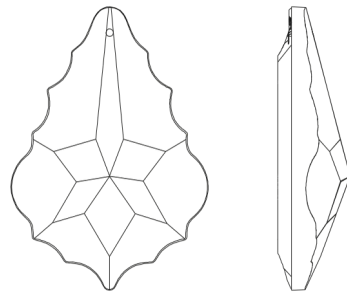

Model 911

Inch

1.5	2	2.5	3	3.5	4	4.5	5
-----	---	-----	---	-----	---	-----	---

mm LxW

38x27	51x36	64x43	76x54
89x62	102x62	114x79	126x89

Colors All colors

Model 917

Inch

2	2.5	3	3.5	4
---	-----	---	-----	---

mm LxW

51x36	64x45	76x54	89x64	100x71
-------	-------	-------	-------	--------

Colors All colors



Pendeloque

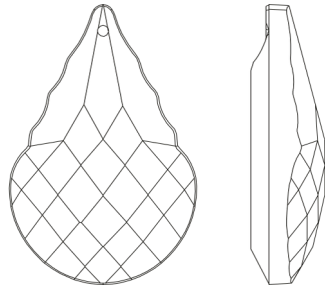

Model 918

Inch

2	2.5	3	3.5
---	-----	---	-----

mm LxW

50x33	61x41	75x50	88x58
-------	-------	-------	-------

Colors All colors

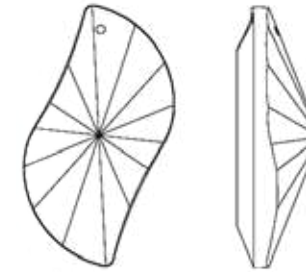

Model 922

Inch

2	2.5	3	3.5	4
---	-----	---	-----	---

mm LxW

51x36	64x45	76x54	89x64
-------	-------	-------	-------

Colors All colors

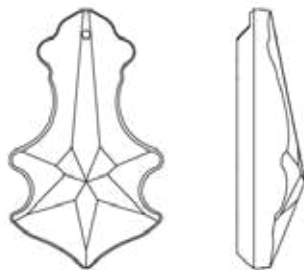

Model 921

Inch

2	2.5	3	3.5	4
---	-----	---	-----	---

mm LxW

51x36	64x45	76x54	89x64	100x71
-------	-------	-------	-------	--------

Colors All colors

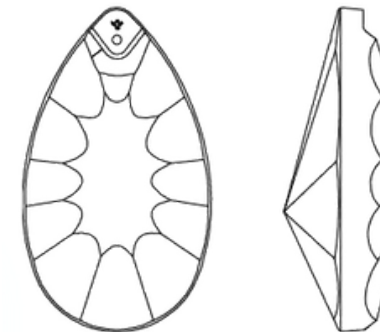
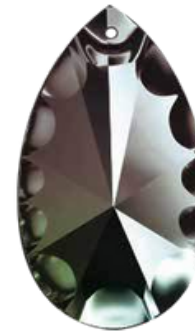

Model 923

Inch

2	2.5	3	3.5	4
---	-----	---	-----	---

mm LxW

51x36	64x45	76x54	89x64	100x71
-------	-------	-------	-------	--------

Colors All colors



Pearshape

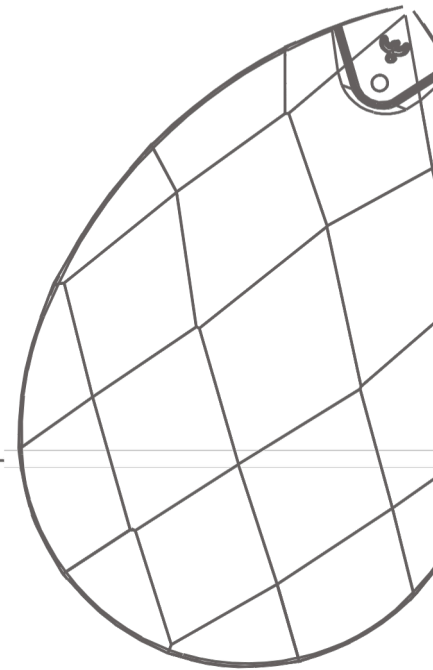
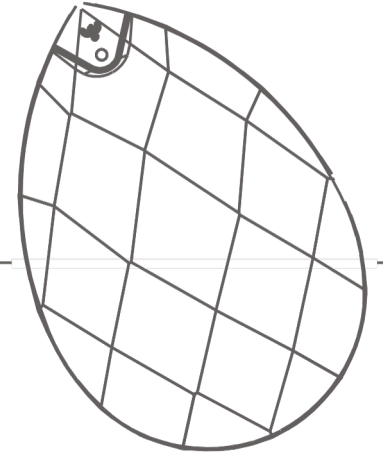



Pearshape

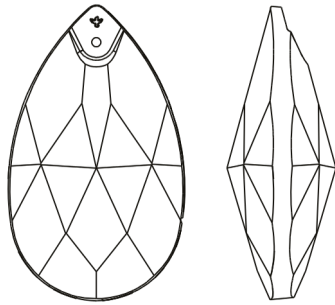

Model 872

Inch
mm LxW

1.5	2	2.5	3	3.5	4
37x12	48x28	61x37	74x44	89x52	100x59

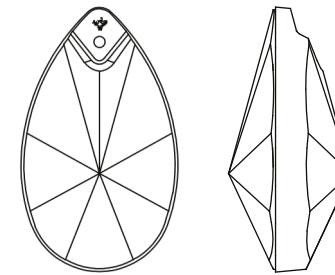

Model 873

Inch
mm LxW
Colors

1.25	1.5	2	2.5	3	3.5	4
28x16	63x21	50x29	63x36	74x42	87x51	99x57
All colors						



Colors All colors

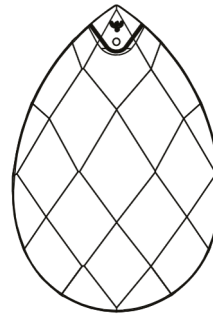

Model 874

Inch

1.5	2	2.5	3	3.5	4	5
-----	---	-----	---	-----	---	---

mm LxW

37x24	49x33	61x42	74x50	86x58	101x67	122x82
-------	-------	-------	-------	-------	--------	--------

Colors

All colors



Coffin Stone

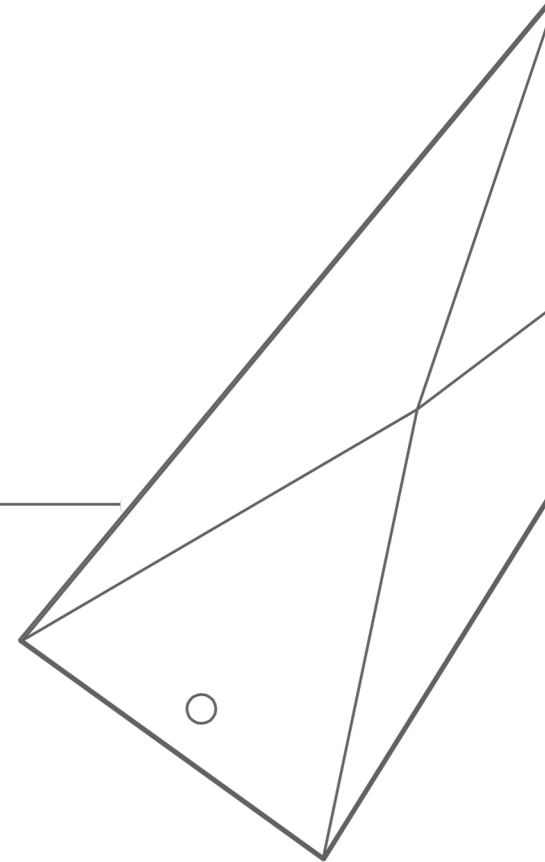
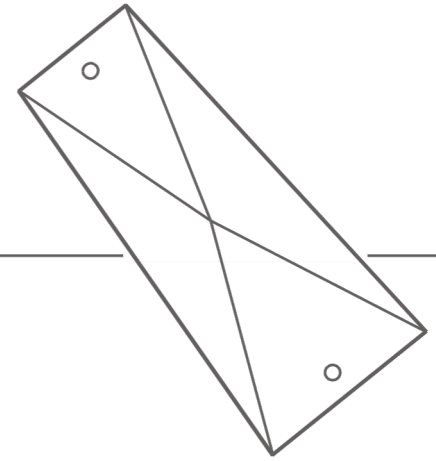



Coffinstone

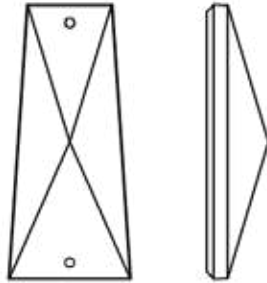

Model 604

Inch 2 2.25 2.5
mm LxW 51X18 58X26 63X30
Colors All colors

Colors

All colors

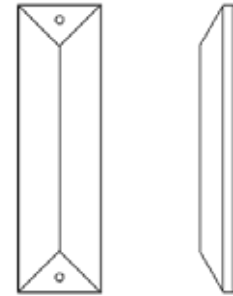

Model 610

Inch 2.5 3 4 6 8 10
mm LxW 63X22 76X22 100X28 150X28 200X28 250X28
Colors All colors

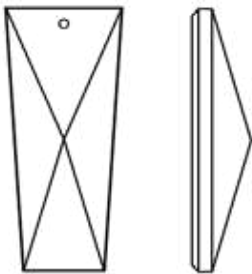

Model 606

Inch 2
mm LxW 52X17



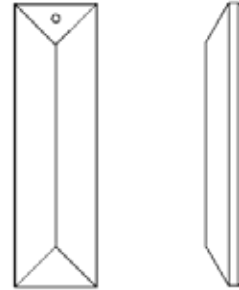

Model 611

Inch
mm LxW
Colors

2.5	3	4	6	8	10
63X22	76X22	100X28	150X28	200X28	250X28
All colors					

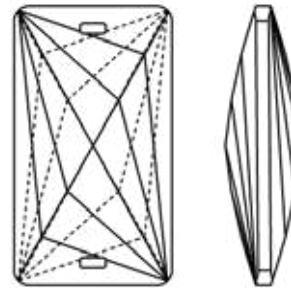

Model 630

Inch
mm LxW
Colors

55
55X22
All colors



Drop

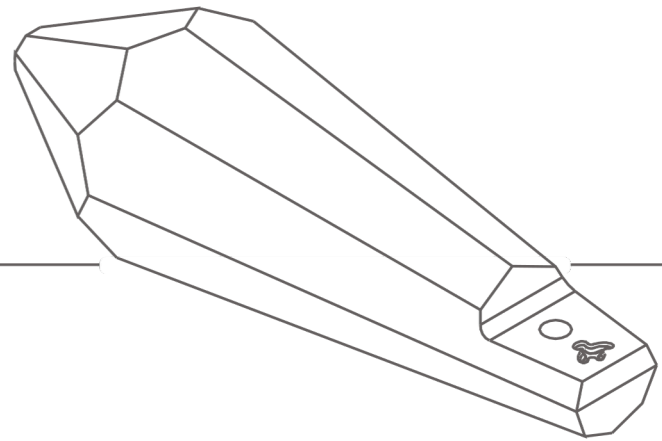
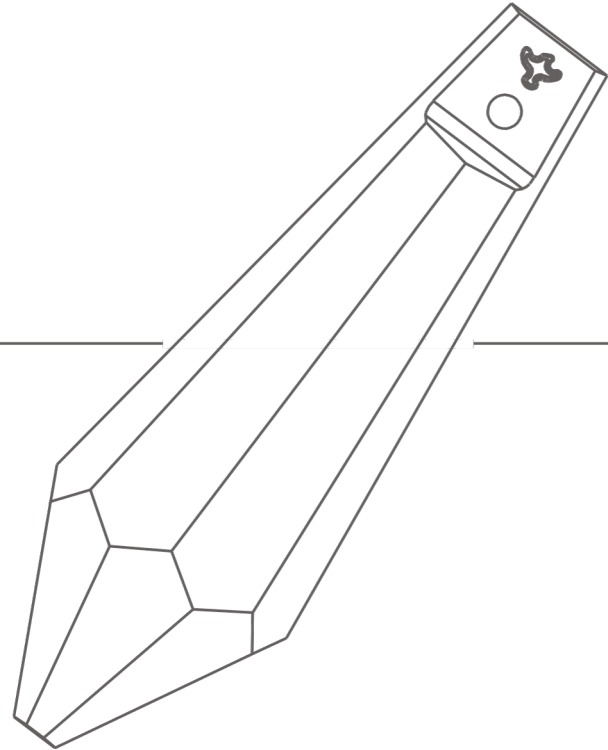



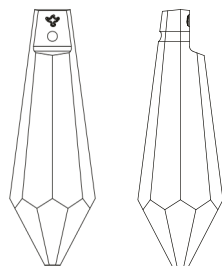

Model 401

Inch

1.5	2	2.5	3
-----	---	-----	---

mm LxW

38x14	50x15	63x15	76x18
-------	-------	-------	-------

Colors All colors

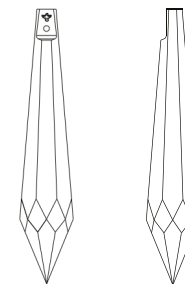

Model 424

Inch

2	2.5	3
---	-----	---

mm LxW

50x15	63x14	76x16
-------	-------	-------

Colors All colors

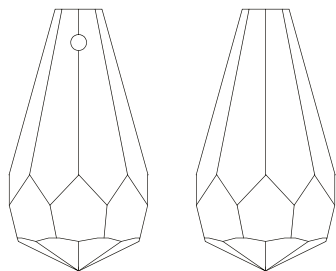

Model 405

Inch

0.8

mm LxW

21x11

Colors Clear



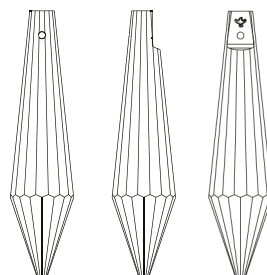

Model 432

Inch
mm LxW
Colors

0.8	1.5	2	2.5	3
21x12	38x12	51x14	62x15	76x17
Clear				

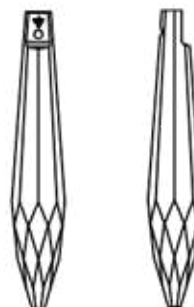

Model 485

Inch
mm LxW
Colors

2.5	3
61X13	76X16
Clear	



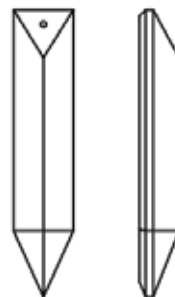

Model 502

Inch 3.5
mm LxW 13X61
Colors Clear

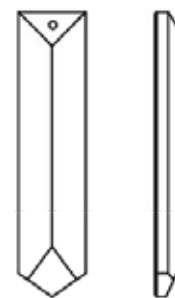

Model 504

Inch 2.5 3
mm LxW 61X17 76X18
Colors All colors

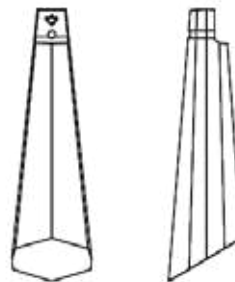

Model 505

Inch

2.5	3	4	5	6
-----	---	---	---	---

mm LxW

63x15	76x16	100x26	125x27	153x31
-------	-------	--------	--------	--------

Colors

All Colors Clear



Model 516

Inch

3.5

mm LxW

87

Colors

All Colors



Bead

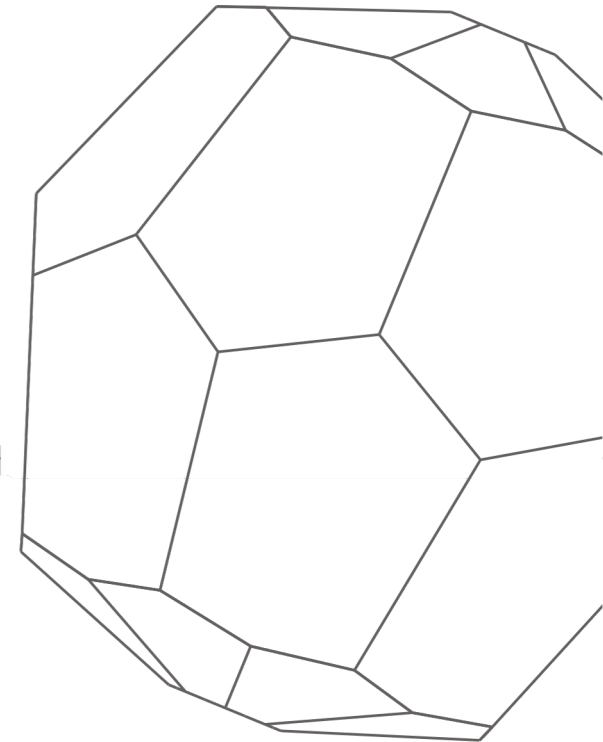
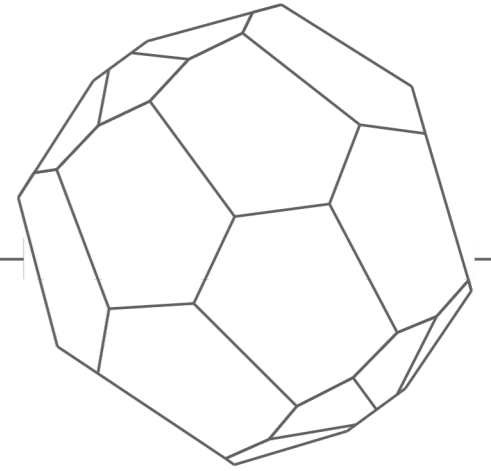

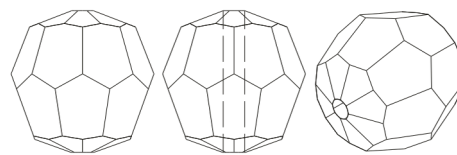

Model 1502

Inch
mm LxW
Colors

5.8x6	7.8x8	9.8x10	11.8x12
13.3x13.5	16x16	18x18	20x20
All Colors			



Ball

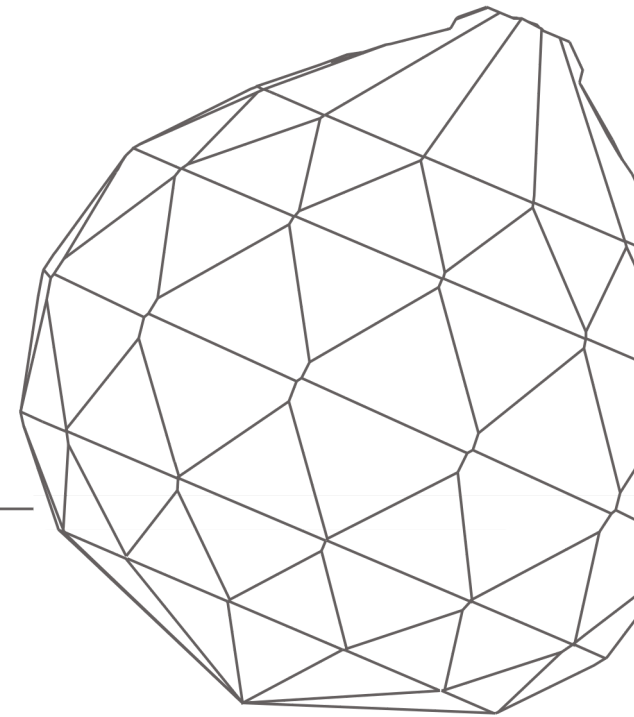
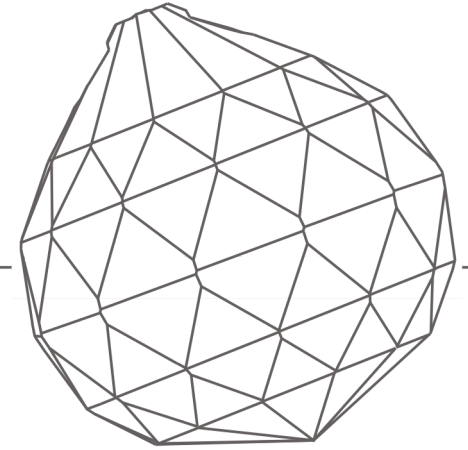



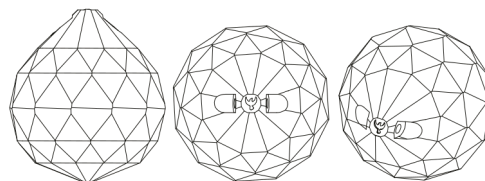

Model 701

mm LxW

20	30	40	50	60	70	100
----	----	----	----	----	----	-----

Colors

All Colors



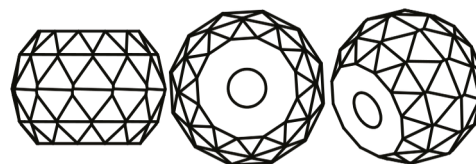

Model 710

mm LxW
Colors

20	30	40	50	70	100
All Colors					



TR

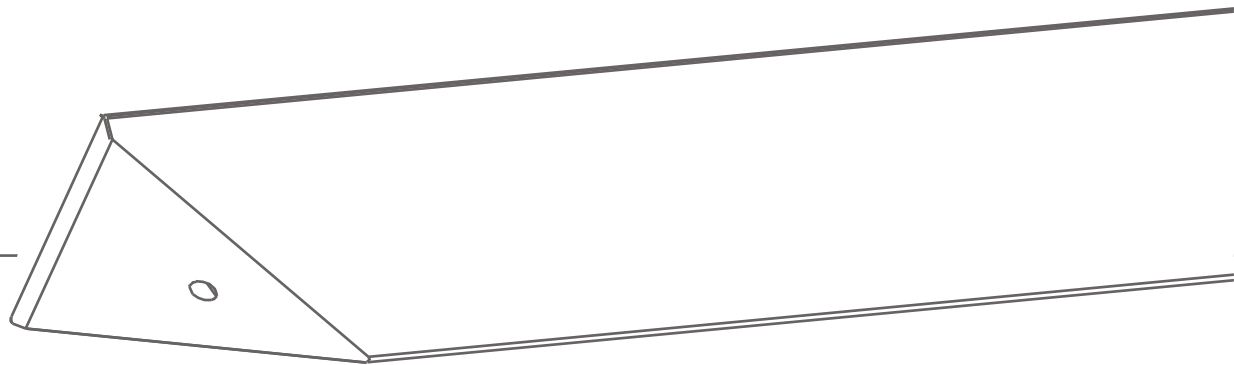

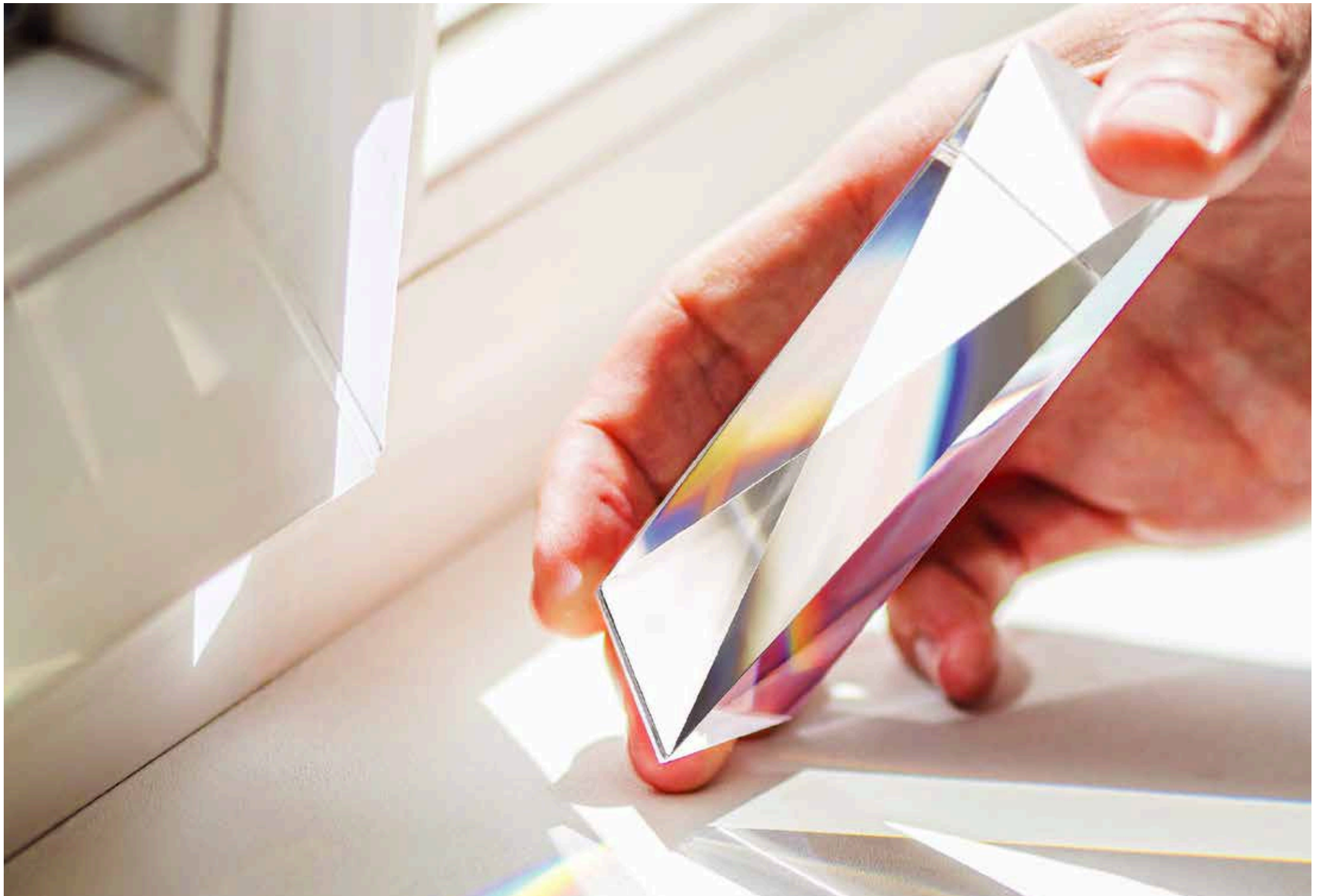

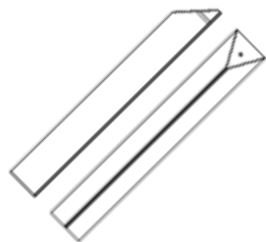

Model TR

mm LxW
Colors All Colors Clear

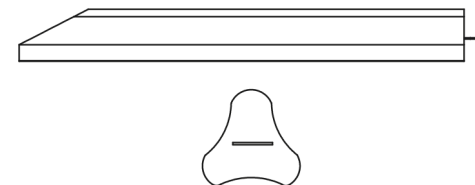

Model TR2

mm LxW
Colors Clear

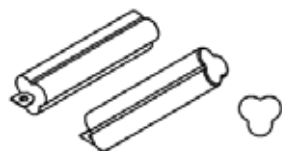

Model TR1

mm LxW
Colors Clear

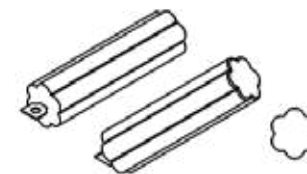

Model TR3

mm LxW
Colors Clear



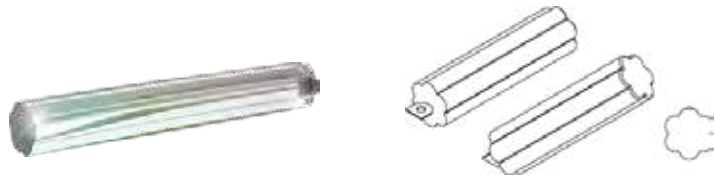

Model TR6

<i>mm LxW</i>	100	150	200	250	300	350	400
	450	500	550	600	650	700	
Colors	Clear						



Model TR8

<i>mm LxW</i>	100	150	200
	Clear		
Colors	Clear		

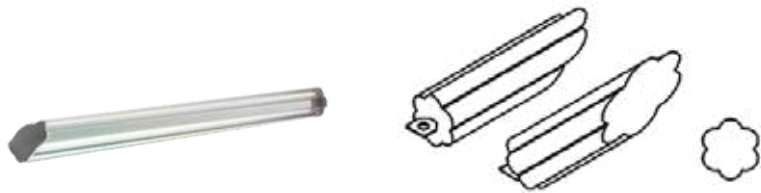

Model TR7

<i>mm LxW</i>	100	150	200	250	300	350	400
	450	500	550	600	650	700	
Colors	Clear						

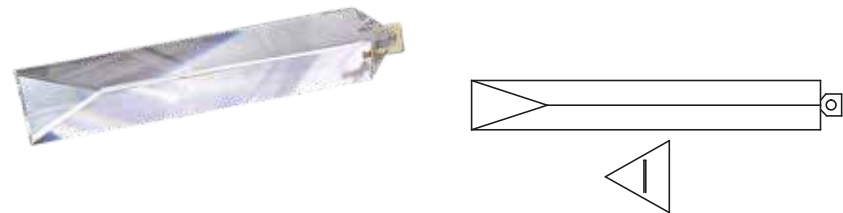

Model TR9

<i>mm LxW</i>	100	150	200
	Clear		
Colors	Clear		





Model TR10

mm LxW

100	150	200	250	300	350	400
450	500	550	600	650	700	

Colors

Clear

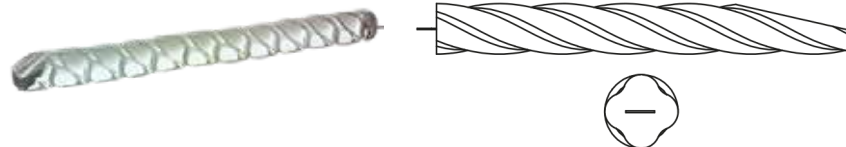

Model TR11

mm LxW

100	150	200	250	300	350	400
450	500	550	600	650	700	

Colors

Clear



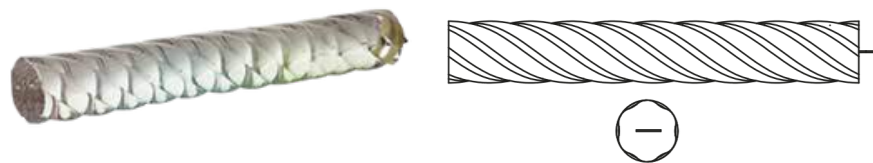

Model TR12

mm LxW

100	150	200	250	300	350	400
-----	-----	-----	-----	-----	-----	-----

450	500	550	600	650	700
-----	-----	-----	-----	-----	-----

Colors

Clear



Chandelier Accessories



Arm

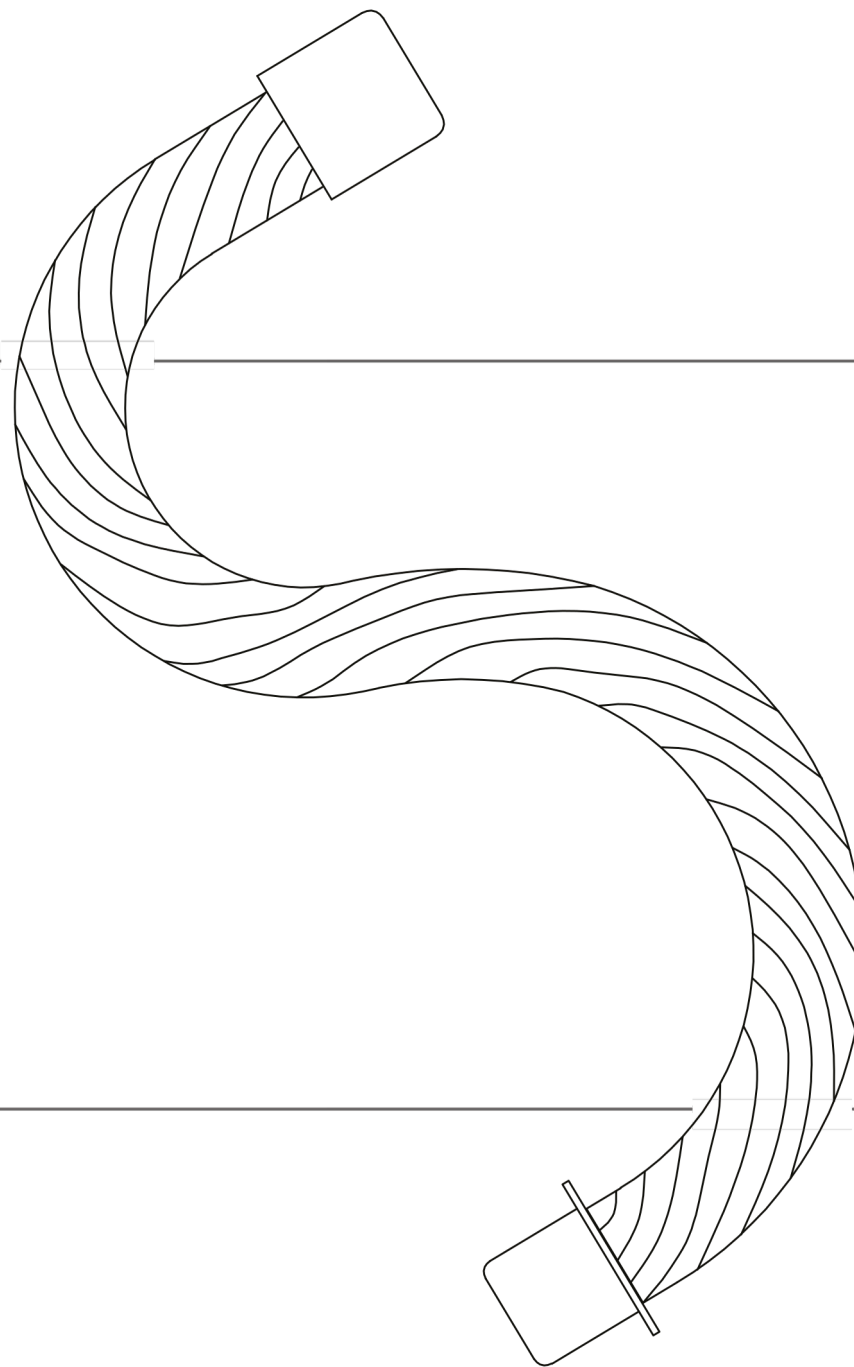





Model ARM1

mm LxW
 Colors Clear

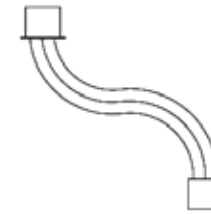

Model Arm 3

mm LxW
 Colors Clear



Model Arm 2

mm LxW
 Colors Clear

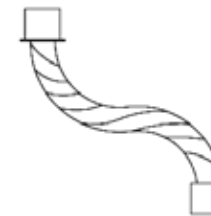

Model Arm 4

mm LxW
 Colors Clear





Model ARM5

mm LxW
 Colors Clear



Model Arm 22

mm LxW
 Colors Clear



Model Arm 6

mm LxW
 Colors Clear



Model ARM23

mm LxW
 Colors All Colors

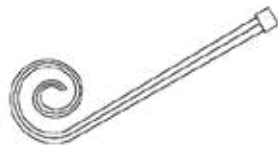

Model Arm 21

mm LxW
 Colors Clear



BOBECH

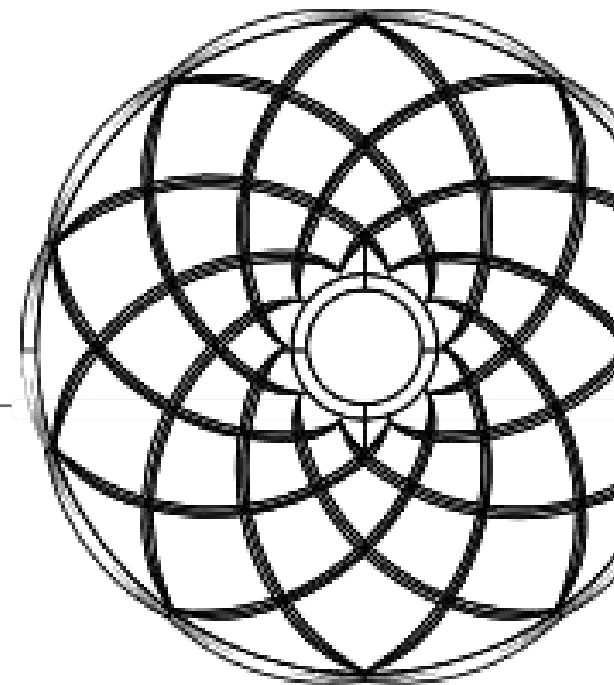
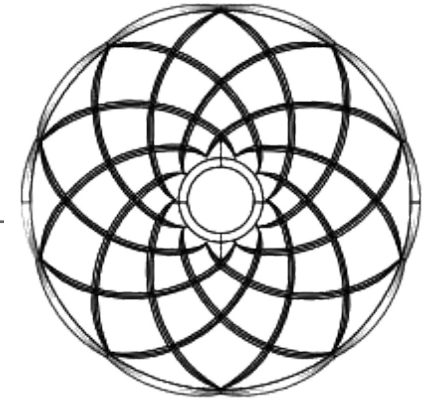



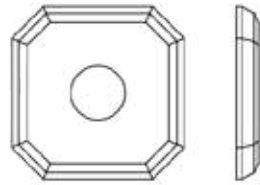

Model Art 100

mm LxW 87 x 87
Colors All Colors

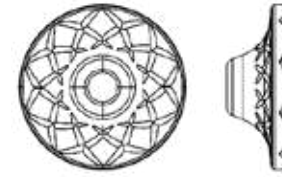

Model Art 102

mm LxW 110
Colors All Colors

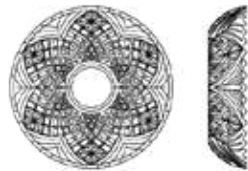

Model Art 101

mm LxW 85 | 100
Colors All Colors



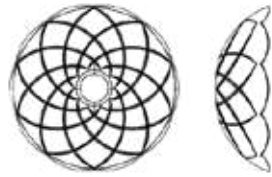

Model Art 103

mm LxW
Colors All Colors

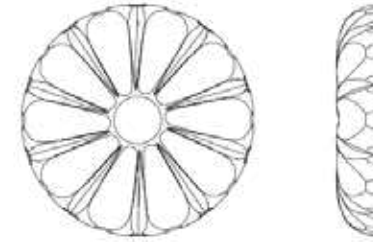

Model Art 105

mm LxW
Colors All Colors

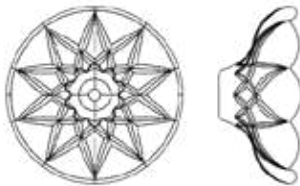

Model Art 104

mm LxW
Colors All Colors



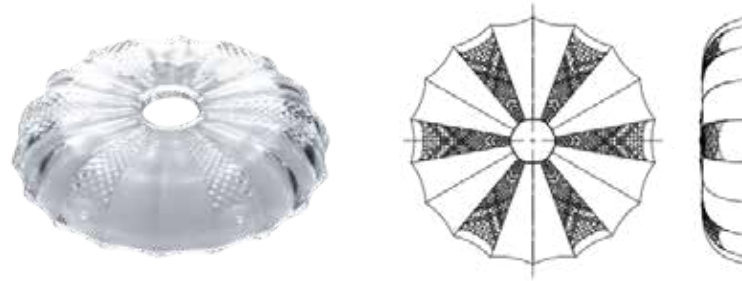

Model Art 106

mm LxW 140
Colors All Colors

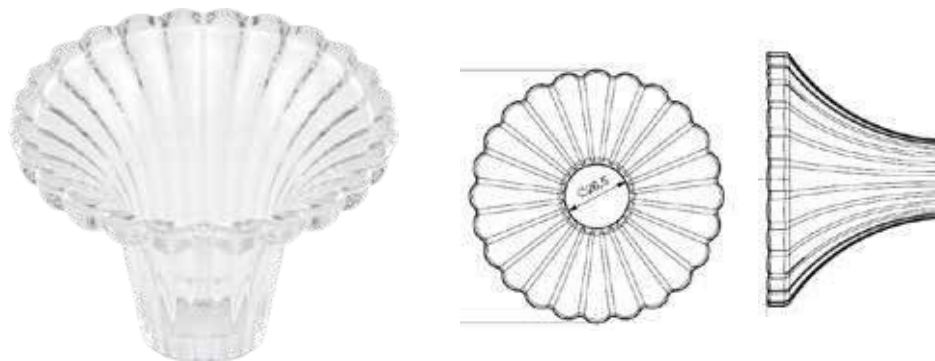

Model Art 107

mm LxW 32 x 74
Colors Green - Clear



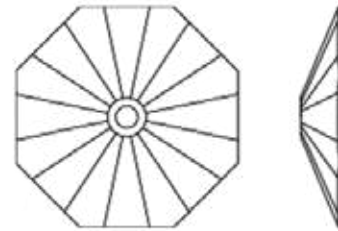
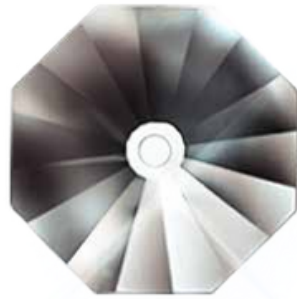

Model Art 1036

mm LxW

100

Colors

All Colors

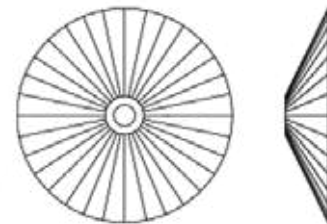
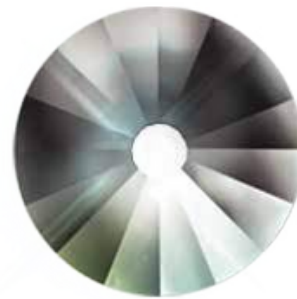

Model Art 1038

mm LxW

100

Colors

All Colors



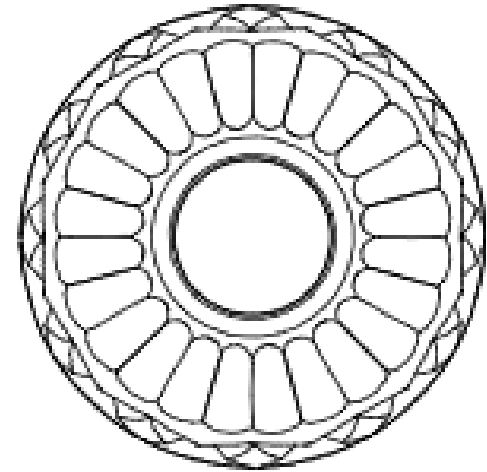

Center Piece

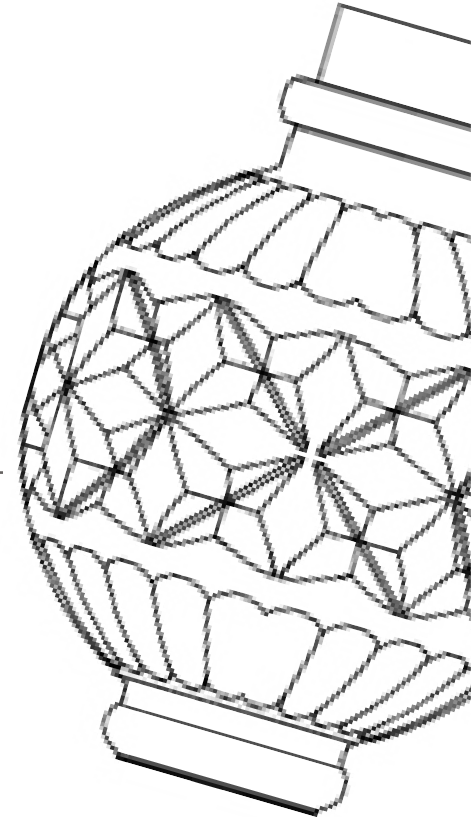



Center Piece



Model Center Piece 1

mm LxW
Colors

130	150	170
Clear		

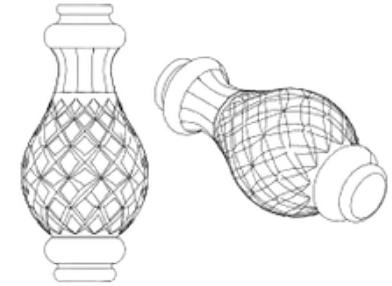

Model Center Piece 3

mm LxW
Colors

168
Clear



Model Center Piece 2

mm LxW
Colors

90	140
Clear	

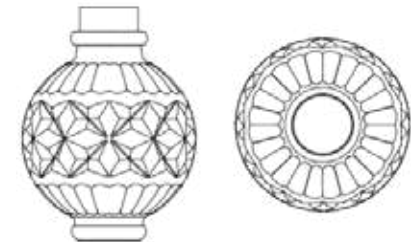

Model Center Piece 4

mm LxW
Colors

100
Clear



Center Piece



Model Center Piece 5

mm LxW 80 165
Colors Clear

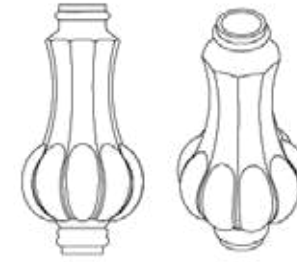

Model Center Piece 7

mm LxW 165
Colors Clear

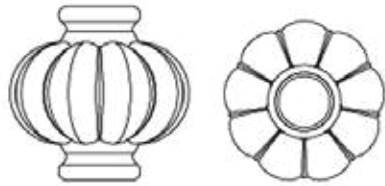

Model Center Piece 6

mm LxW 76
Colors Clear





Rosita



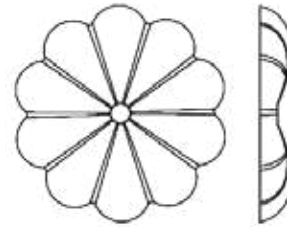

Model 1006

mm LxW
Colors

14	20	24	30
Clear			





The Crystal Breeze

UNLIMITED POSSIBILITIES

From nature to you, Inspired by articulate details in nature, The Crystal Breeze line is a nature from different perspective, vibrant color arrangements, and depth of detail coupled with serene lighting effects.

All these features combined with limitless product coloring, sizes and packing customizability, that can satisfy any ambitious decorative design applications.

Colors

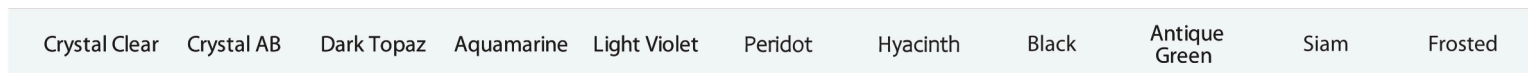

**imagine no limits of coloring possibilities
and Contact our team**



Evergreen

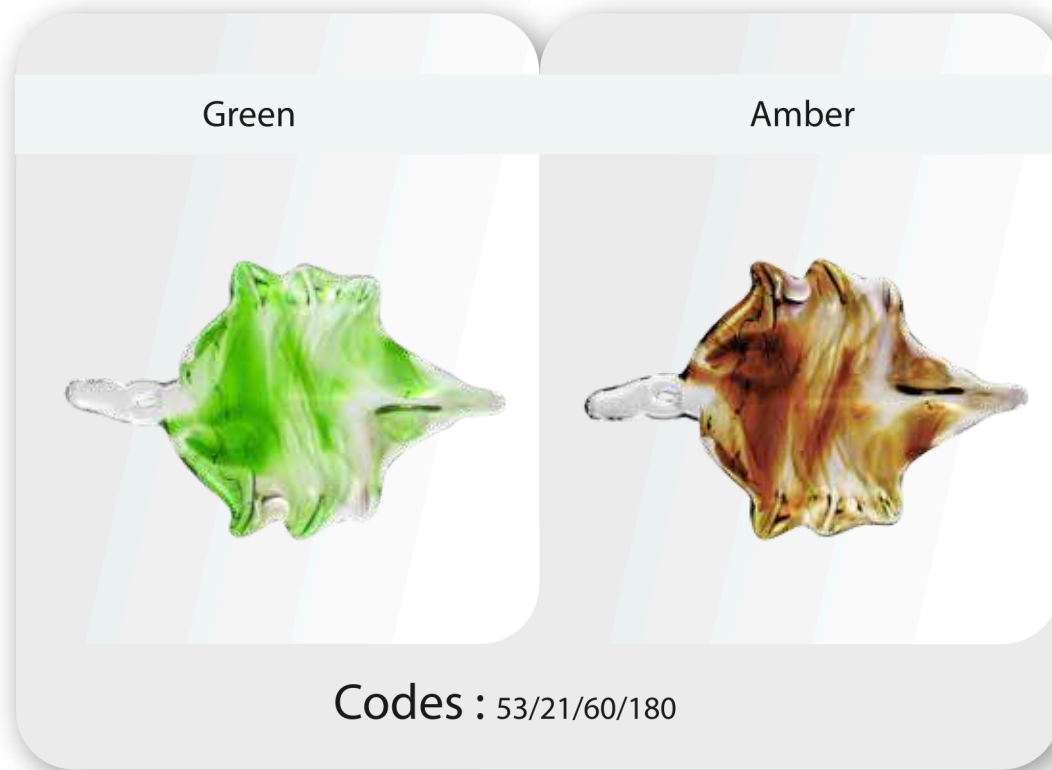

- Entirely handmade product
- Special sizes and shapes can be arranged

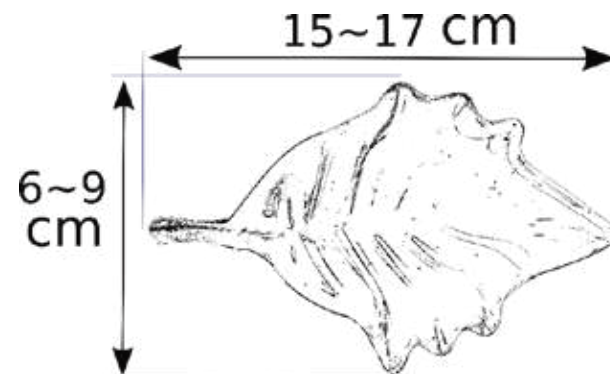



Feather

	Holes	Clear	Light Topaz	Dark Topaz	Violet	Frosted	Dimensions
Feather 1	1	85/81/111/20	85/81/11/12	85/81/11/13	85/81/11/66	85/81/111/209	L:23cm - W:7cm
	2	85/81/112/20	85/81/21/12	85/81/12/13	85/81/12/66	85/81/112/209	
	4	85/81/114/20	85/81/41/12	85/81/14/13	85/81/14/66	85/81/114/209	
Feather 2	1	85/81/21/20	85/81/12/12	85/81/21/13	85/81/21/66	85/81/21/209	L:26cm - W:12cm
	2	85/81/22/20	85/81/22/12	85/81/22/13	85/81/22/66	85/81/22/209	
	4	85/81/24/20	85/81/42/12	85/81/24/13	85/81/24/66	85/81/24/209	
Feather 3	1	85/81/311/20	85/81/31/12	85/81/31/13	85/81/31/66	85/81/311/209	L:28cm - W:8cm
	2	85/81/312/20	85/81/32/12	85/81/32/13	85/81/32/66	85/81/312/209	
	4	85/81/314/20	85/81/34/12	85/81/34/13	85/81/34/66	85/81/314/209	
Feather 4	1	85/81/41/20	85/81/411/12	85/81/41/13	85/81/41/66	85/81/41/209	L:25cm - W:14cm
	2	85/81/42/20	85/81/412/12	85/81/42/13	85/81/42/66	85/81/42/209	
	4	85/81/44/20	85/81/414/12	85/81/44/13	85/81/44/66	85/81/44/209	



Feather
1



Feather
2



Feather
3

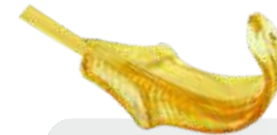

Feather
4



1 Hole



2 Hole



4 Hole



Tree Light

Color	Code
Clear	85/82/3/20
Antique Green	85/82/3/4
Peridot	85/82/3/8
Tanzanite	85/82/3/5
Topaz	85/82/3/12
Violet	85/82/3/66

Color	Code
Frost	95/82/1/209
Antique Green Matte	95/82/1/49
Peridot Matte	95/82/1/89
Tanzanite Matte	95/82/1/59
Topaz Matte	95/82/1/139
Violet Matte	95/82/1/669

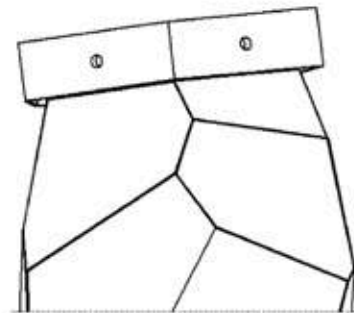
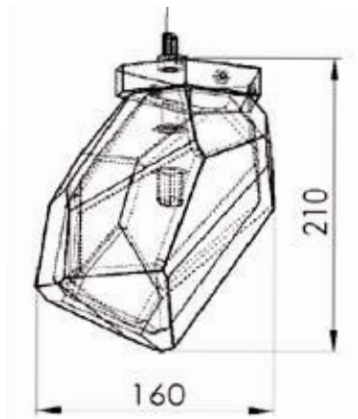



Flutterers

Codes		Crystal Clear	Crystal AB	Dark Topaz	Aquamarine	Light Violet	Peridot	Hyacinth	Black	Antique Green	Siam
Big		94/21/75/85	94/2192/75/85	94/33/30/90	94/15/30/90	94/54/30/90	94/23/30/90	94/43/30/90	94/55/30/90	94/22/30/90	94/40/30/90
Small		94/21/60/65	94/2192/60/65	94/33/20/85	94/15/20/85	94/54/20/85	94/23/20/85	94/43/20/85	94/55/20/58	94/22/20/58	94/40/20/58



Small

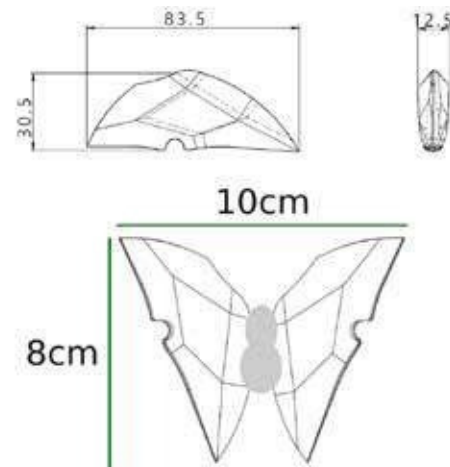
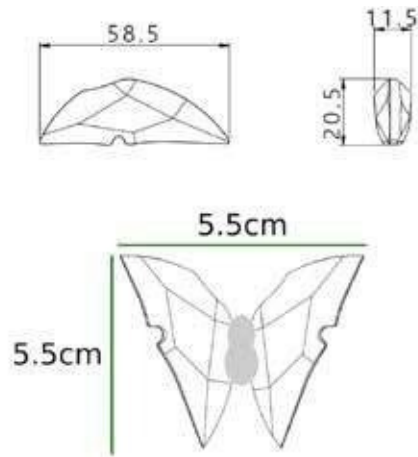

Big



Crystal Cookies

Colors	Holes	Codes	Dimensions
Clear Topaz Black Diamond Jonquil	Center Hole 1.6 mm	85/55/1/20 85/55/0/20 85/55/9/20 85/55/7/10	5.5 CM
Clear Topaz Black Diamond Jonquil		85/72/1/20 85/72/2/20 85/72/7/20 85/72/4/10	7.2 CM





Hover

Shape	Connector	Color	Wire	Code
Open Shape	Chrome Connector	Frosted White	600 mm wire	21-3186
Closed Shape	Chrome Connector	Frosted White	600 mm wire	21-3185



Opened

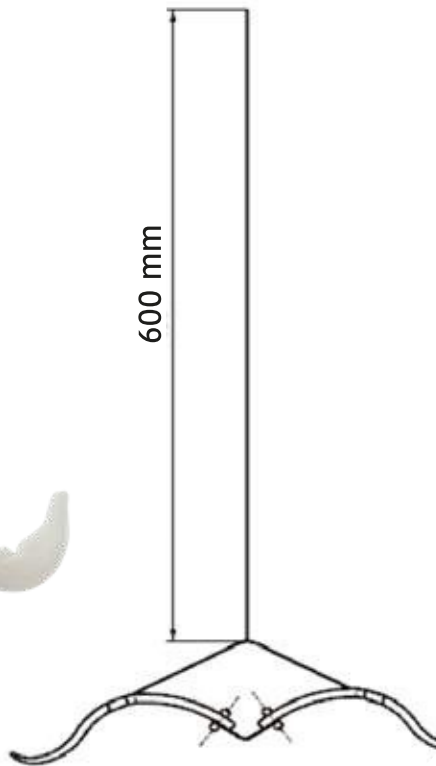

Closed

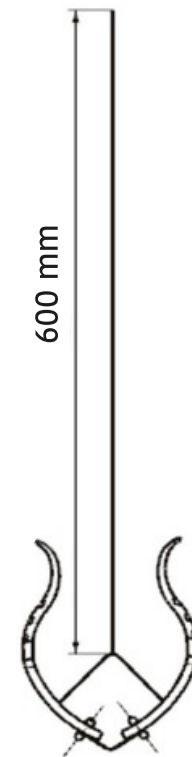



Sky Light

Color	Hole Central 18 mm	Texture 1 Form 1	Texture 1 Form 2	Texture 2 Form 1	Texture 2 Form 2
Siam	Y	85/35/112/10	85/35/112/110	85/35/111/10	85/30/111/110
	N	90/35/112/10	90/35/112/110	90/35/111/10	90/30/111/110
Light Violet	Y	85/35/112/66	85/35/112/166	85/35/111/66	85/30/111/166
	N	90/35/112/66	90/35/112/166	90/35/111/66	90/30/111/166
Aquamarine	Y	85/35/112/14	85/35/112/114	85/35/111/14	85/30/111/114
	N	90/35/112/14	90/35/112/114	90/35/111/14	90/30/111/114
Peridot	Y	85/35/112/8	85/35/112/118	85/35/111/8	85/30/111/118
	N	90/35/112/8	90/35/112/118	90/35/111/8	90/30/111/118
Hyacinth	Y	85/35/112/11	85/35/112/111	85/35/111/11	85/30/111/111
	N	90/35/112/11	90/35/112/111	90/35/111/11	90/30/111/111
Dark Topaz	Y	85/35/112/13	85/35/112/113	85/35/111/13	85/30/111/113
	N	90/35/112/13	90/35/112/113	90/35/111/13	90/30/111/113

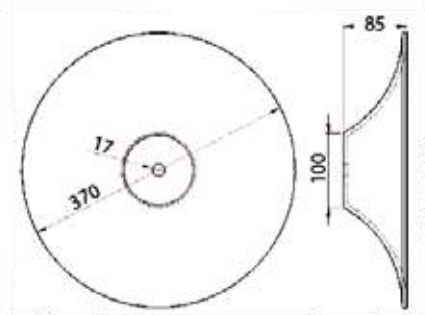

Texture 1
Form 1

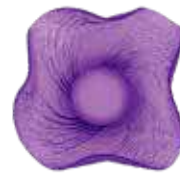

Texture 1
Form 2



Texture 2
Form 1

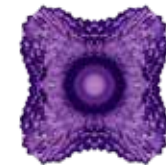

Texture 2
Form 2



Fiona

Shape	Glass Texture	Colors							Dimensions
		Light Topaz	Violet	AntiqueGreen	Tanzanite	Emerald	Milky	White Rose	cm
S 1	Smooth	95/80/1/12	95/80/1/66	95/80/1/14	95/80/1/5	95/80/1/44	—	—	L = 130 -160 w = 40 - 50
S 1	Line Grooves	95/800/1/12	95/800/1/66	95/800/1/14	95/800/1/5	95/800/1/44	—	—	
S 2	Smooth	95/80/2/12	95/80/2/66	95/80/2/14	95/80/2/5	95/80/2/44	—	—	
S 2	Line Grooves	95/800/2/12	95/800/2/66	95/800/2/14	95/800/2/5	95/880/2/44	—	—	
S 3	Smooth	95/80/3/12	95/80/3/66	95/80/3/14	95/80/3/5	95/80/3/44	—	—	
S 3	Line Grooves	95/800/3/12	95/800/3/66	95/800/3/14	95/800/3/5	95/800/3/44	—	—	
Rose	Line Grooves	—	—	—	—	—	85/76/4/55	85/76/4/155	L = 130 -160 w = 10
Straight	Smooth	85/76/5/12	—	85/76/5/4	85/76/5/5	—	—	—	L = 120 -140

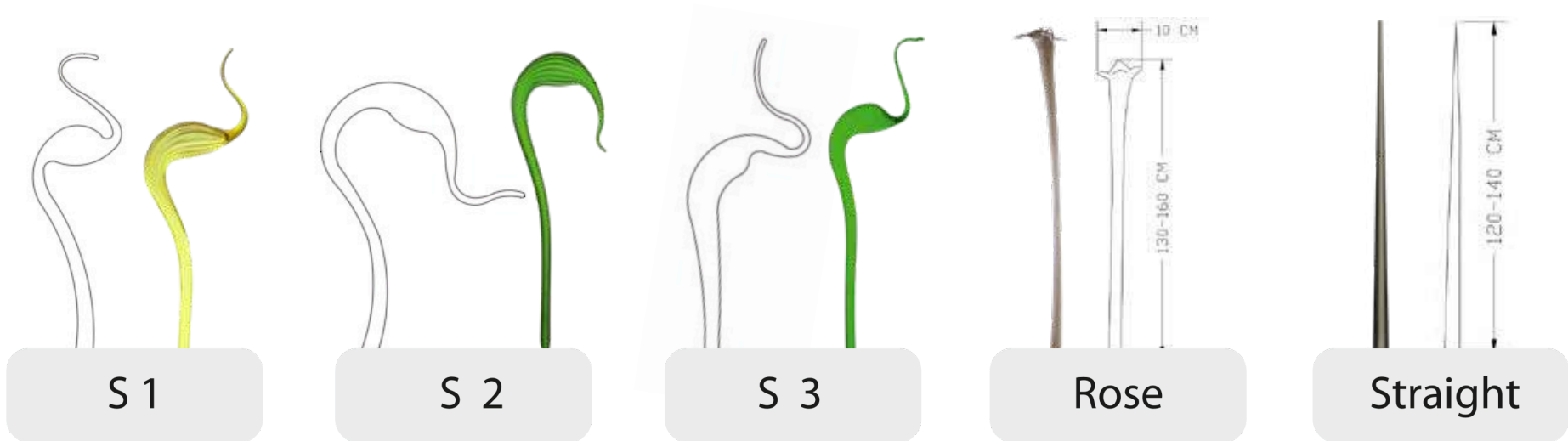

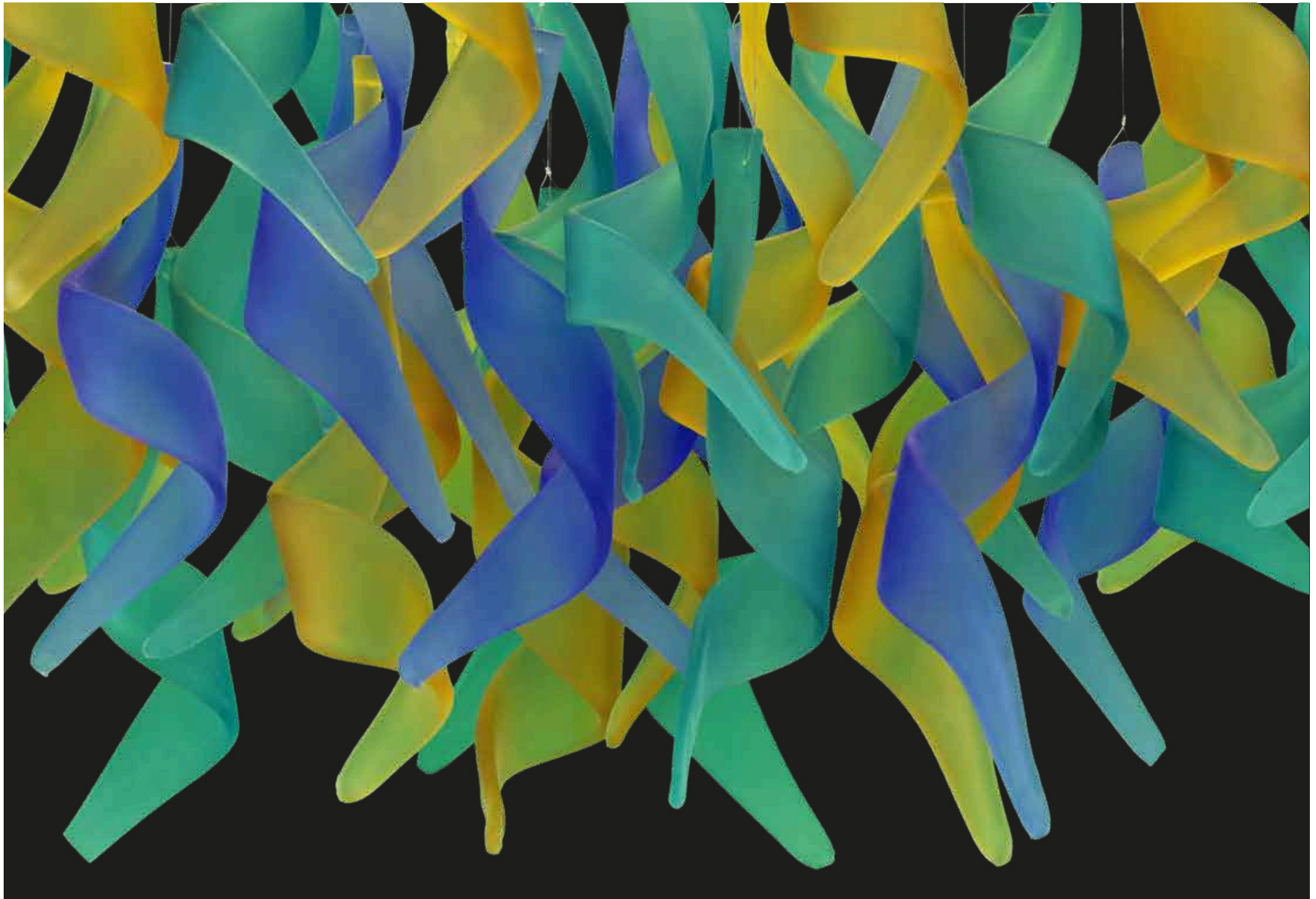

Spiral Leaves

Colors	Codes
Matte Sapphire	85/67/363/70
Matte Light Topaz	85/67/360/71
Matte Antique Green	85/67/364/71

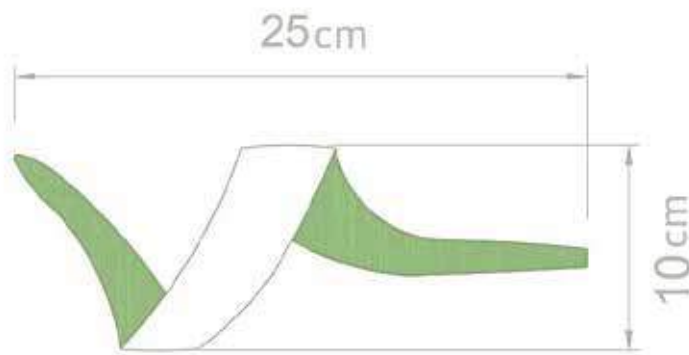

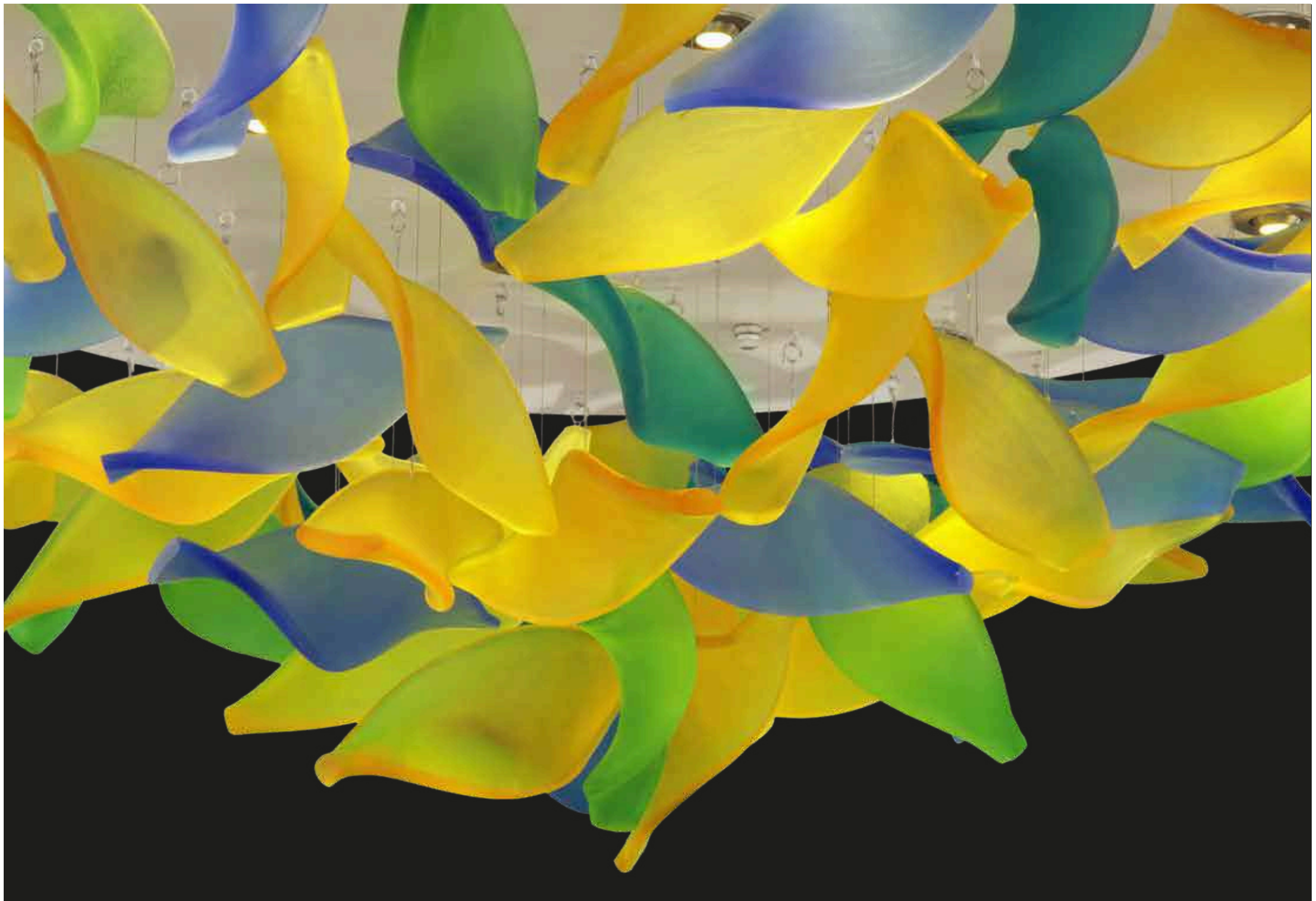

Leaves

Colors	Codes
Matte Light Sapphire	85/67/93/221
Matte Peridot	85/65/98/22
Matte Antique Green	85/67/94/221
Matte Jonquil	85/65/97/22

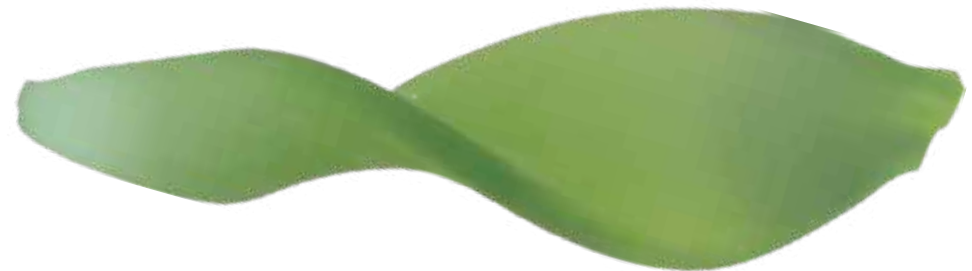
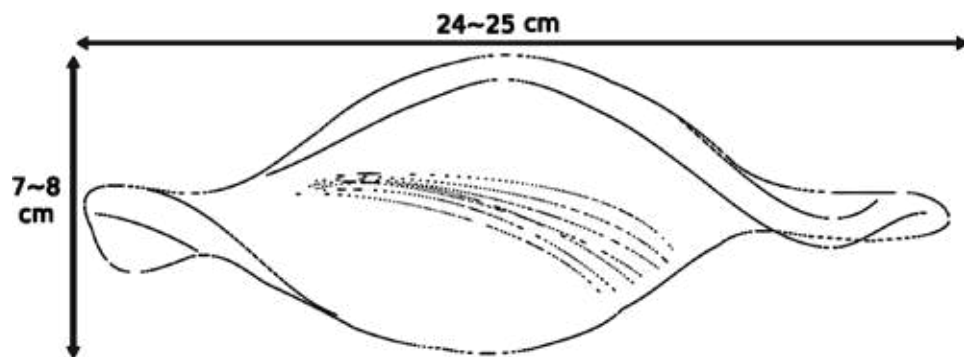

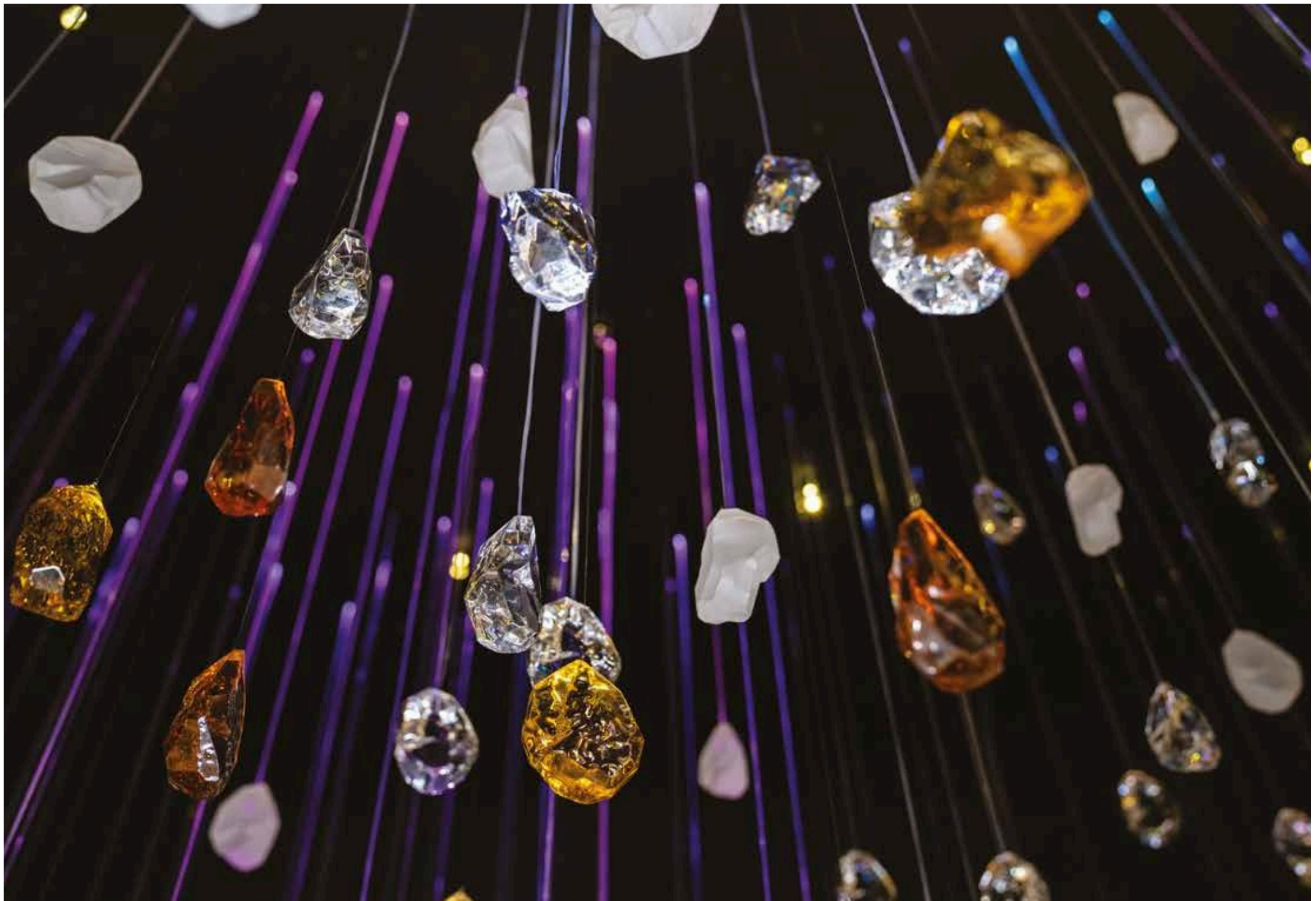

Galaxy

Colors	Codes	mm	Inch
Crystal Clear	15/878/35/6	87	3.5
Antique Green	15/878/35/6248	87	3.5
Violet	15/878/35/6667	87	3.5
Hyacinth	15/878/35/6117	87	3.5
Siam	15/878/35/6107	87	3.5
Aquamarine	15/878/35/6148	87	3.5
Dark Topaz	15/878/35/6137	87	3.5

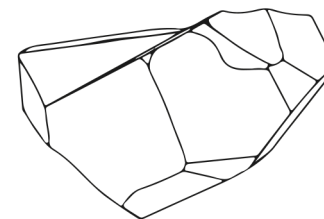
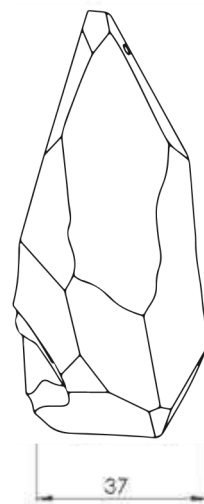
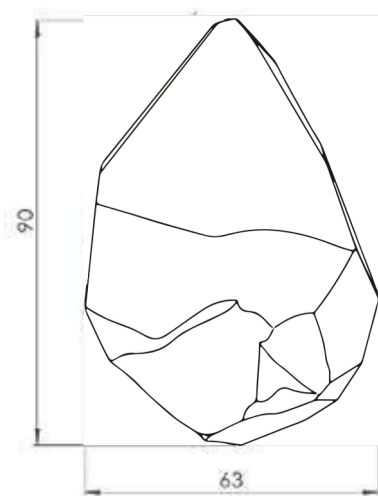

Terms And Conditions



Terms And Conditions

General

- ✦ The Client's purchase of Asfour Crystal products represents acceptance of these terms and conditions.
- ✦ No change or modification of any of these terms and conditions shall be valid or binding on either party unless in writing and signed by the authorized representatives of each party.
- ✦ No liability for typographical errors.
- ✦ All mentioned data are subjected to +10% tolerance.
- ✦ Asfour Crystal reserves the right to change payment terms or to discontinue performance under any agreement with client any time.

Terms And Conditions

Orders

- ✎ Minimum order value may apply as communicated by Asfour Crystal.
- ✎ Contact our sales team for more information about minimum order quantity

Products

- ✎ Asfour Crystal may change its product specification at any time.
- ✎ Information appearing in catalogue such as color, quality or dimensions will be binding only when referenced in the order acknowledgement.
- ✎ Deviation due to manufacturing process, e.g. in qualities, colors, dimensions, weights and product qualities are permissible.

Terms And Conditions

Prices

- ✎ Prices are subject to change without prior notice.
- ✎ Prices are based on "FOB" Egypt basis.
- ✎ All prices change are subjected to price list, In effect of late of delivery. And other prices quoted by Asfour Crystal are valid only for ONE month only.

Packages

- ✎ In the absence of specific agreements, the packaging is chosen by Asfour Crystal.
- ✎ Asfour Crystal has the right to change the packaging without prior notification.

Terms And Conditions

Delivery

- ✎ All deliveries are made according to Incoterms FOB + Asfour Crystal shall not be liable for any delay in performance hereunder due to unforeseen circumstances or due to causes beyond.
- ✎ Asfour Crystal's control, including but not limited to force majeure, acts of government, military conflicts, delays in transportation or customs formalities transport damages, energy shortages or labor disputes and delay in delivery or inability to deliver by Asfour's supplies.
- ✎ Delivery depends on goods availability.

Terms And Conditions

Packing

Make sure of purchasing the authenticated Asfour Crystal Crystal's products. To ensure that this is an original Asfour Crystal Crystal product, please look for the following.

ON THE OUTER CARTON

- 1- Complete company data printed on the carton.
- 2- The “sealed by” safety sticker.



The “L” letter beside the product code on Asfour Crystal Crystal's labels indicates that this item is engraved with the logo.

Terms And Conditions

On The Inner Box (Duplex)

- 1- The engraved Asfour Crystal logo on the inner pallets.
- 2- The “sealed by” safety sticker.



Terms And Conditions

Place

- ✎ Client's is liable for market only and not allowed to open a direct contract channel with another territory unless obtains a prior written approval from Asfour Crystal.

Data Protection

- ✎ Client is liable not to share information with third parties.

Terms And Conditions

Terms of Payment

- ✦ Payment shall be made in advance, unless agreed otherwise in writing.
- ✦ In case of different payment terms offer than prepayment, Asfour Crystal may demand a bank guarantee or other form of security acceptable to Asfour Crystal.
- ✦ Payment is affected when the amount invoiced is credited on the account indicated by Asfour Crystal.

Packing Details

Octagon

<i>Model</i>	<i>Dimintions mm LXM</i>	<i>PCs Per Duplex</i>	<i>Part weight in gms</i>	<i>Duplex weight in gms</i>	<i>Engraved</i>
1080	12	2132	1.25	3.19	No
	14	2000	1.82	4.18	No
	16	1188	2.56	3.383	No
	18	960	3.2	3.6	No
	20	585	4.5	3.11	No
	22	520	6.16	3.22	No
	24	368	7.27	2.94	No
	26	308	8.98	3.2	No
	28	308	10.26	3.69	No
	30	180	14.44	2.68	No
	32	162	16.5	2.96	No
	34	144	18.5	3.199	No
	36	120	23	3.15	No
	38	120	27.1	4.448	No
	40	85	28	2.802	No
1081	14	2000	2	3.8	No
1083	16	1188	2.2	3.3	No
	24	368	7.6	2.925	No

<i>Model</i>	<i>Dimintions mm LXM</i>	<i>PCs Per Duplex</i>	<i>Part weight in gms</i>	<i>Duplex weight in gms</i>	<i>Engraved</i>
1032	14	2000	2	4.445	No
1020	12	2132	-	-	-
	14	2000	-	-	-
	16	1188	-	-	-
	18	960	-	-	-
	20	585	-	-	-
	22	520	-	-	-
	24	368	-	-	-
	26	308	-	-	-
	28	308	-	-	-
	30	180	-	-	-
	32	162	-	-	-
	34	144	-	-	-
	36	120	-	-	-
	38	120	-	-	-
	40	85	-	-	-
50	48	-	-	-	
1090	22	325	-	-	No
	24	220	-	-	No

Packing Details

Square

<i>Model</i>	<i>Dimentions mm LXM</i>	<i>PCs Per Duplex</i>	<i>Part weight in gms</i>	<i>Duplex weight in gms</i>	<i>Engraved</i>
<i>2020</i>	14	1500	2.3	3.94	No
	16	1188	2.95	4.09	No
	18	960	3.96	4.51	No
	20	585	5.41	3.616	No
	22	520	7.36	3.476	No
	24	308	8.82	3.26	No
	26	308	10.69	4.12	No
	28	264	14.2	3.93	No
<i>2024</i>	14	1500	2.3	3.846	No
	16	1188	2.68	3.507	No
	18	960	3.89	4.157	No
	20	585	4.91	3.209	No
	22	520	6.16	3.784	No
	24	308	8.6	3.042	No
	26	308	12	4.059	No
	28	264	13.83	4.01	No

Round

<i>Model</i>	<i>Dimentions mm LXM</i>	<i>PCs Per Duplex</i>	<i>Part weight in gms</i>	<i>Duplex weight in gms</i>	<i>Engraved</i>
<i>1040</i>	40	85	31.4	3.024	No
	45	68	31.4	3.024	No
<i>1041</i>	40	85	43	3.202	No
	45	68	32	3.024	No

Packing Details

Pendeloque

Model	Dimentions		PCs Per Duplex	Part weight in gms	Duplex weight in gms	Engraved
	Inch	mm LXM				
910	2	50x35	140	26.6	4.08	Yes
	2.5	62x43	80	50.2	4.4	Yes
	3	75x53	48	79.2	4.4	Yes
	3.5	89x62	32	126.6	4.1	Yes
911	1.5	38x27	384	9.77	4.41	No
	2	51x36	140	24.6	3.85	Yes
	2.5	64x43	80	47.38	3.97	Yes
	3	67x54	48	77.91	3.996	Yes
	3.5	89x62	32	119.5	4.076	Yes
	4	102x62	20	146.7	3.255	Yes
	4.5	114x79	16	224	3.93	Yes
914	2.5	64x30	98	31.24	3.524	No
	3.5	89x62	32	126.6	4.1	Yes
917	2	51x36	144	25.08	4.12	Yes
	2.5	64x45	75	45.76	3.87	Yes
	3	76x54	40	73.77	3.403	Yes
	3.5	89x64	21	124	2.93	Yes
	4	100x71	18	159.3	3.988	Yes

Model	Dimentions		PCs Per Duplex	Part weight in gms	Duplex weight in gms	Engraved
	Inch	mm LXM				
918	2	50x33	140	27.67	4.42	Yes
	2.5	61x41	80	46.95	4.2	Yes
	3	75x50	48	82.83	4.42	Yes
	3.5	88x58	24	126.95	3.48	Yes
921	2	51x36	168	20.5	3.82	Yes
	2.5	64x45	90	35.1	3.77	Yes
	3	76x45	60	59.11	3.99	Yes
	3.5	89x64	20	88.57	2.182	Yes
	4	100x71	24	103.75	2.89	Yes
922	2	51x36	144	34	3.37	Yes
	2.5	64x45	80	58.3	3.4	Yes
	3	76x54	48	98.14	3.52	Yes
	3.5	89x64	20	156.64	2.43	Yes
923	2	51x36	135	29.67	3.93	Yes
	2.5	64x45	72	50	3.542	Yes
	3	76x54	40	83.23	2.9	Yes
	3.5	89x64	24	135.4	3.5	Yes
	4	100x71	15	172	3.5	Yes

Packing Details

Pearshape

Model	Dimentions		PCs Per Duplex	Part weight in gms	Duplex weight in gms	Engraved
	Inch	mm LXM				
872	1.5	37x12	308	12.55	4.144	No
	2	48x28	135	28.45	4.06	Yes
	2.5	61x37	72	62.83	4.17	Yes
	3	74x44	40	87.35	3.918	Yes
	3.5	89x52	24	162	4.164	Yes
	4	100x59	14	237.4	3.95	Yes
873	1.25	28x16	504	6.35	3.727	No
	1.5	63x21	308	9.57	3.598	No
	2	50x29	135	24.94	4.19	Yes
	2.5	63x36	72	55.1	3.755	Yes
	3	74x42	30	88.77	3.004	Yes
	3.5	87x51	24	139.7	3.688	Yes
874	4	99x57	14	183.4	3.298	Yes
	1.5	37x24	224	10	3.922	No
	2	49x33	96	36.04	3.903	No
	2.5	61x42	45	72.7	3.495	Yes
	3	74x50	30	113	3.745	Yes
	3.5	86x58	18	190	3.848	Yes
	4	101x67	12	298	3.89	Yes
	5	122x82	6	543	2.938	Yes

Coffin Stone

Model	Dimentions		PCs Per Duplex	Part weight in gms	Duplex weight in gms	Engraved
	Inch	mm LXM				
604	2	51x18	288	14	4.582	No
	2.25	58x26	168	24	4.292	Yes
	2.5	63x30	100	35.93	3.952	No
606	2	52x17	324	12	2.85	No
610	2.5	63x22	175	21.75	4.448	Yes
	3	76x22	128	31.26	4.247	Yes
	4	100x28	50	72.4	4.283	Yes
	6	150x28	30	70.00	3.55	Yes
	8	200x28	15	138.6	2.643	Yes
	10	250x28	15	156	2.893	Yes
611	2.5	63x22	175	21.75	4.662	Yes
	3	76x22	128	30.1	4.25	Yes
	4	100x28	50	73	4.2	Yes
	6	150x28	30	-	3.578	Yes
	8	200x28	15	116.6	2.621	Yes
	10	250x28	15	165	3.195	Yes
630 <small>Special order</small>	55	55x22	90	40	4.55	Yes

Packing Details

Drop

<i>Model</i>	<i>Dimentions</i>		<i>PCs Per Duplex</i>	<i>Part weight in gms</i>	<i>Duplex weight in gms</i>	<i>Engraved</i>	<i>Model</i>	<i>Dimentions</i>		<i>PCs Per Duplex</i>	<i>Part weight in gms</i>	<i>Duplex weight in gms</i>	<i>Engraved</i>						
	<i>Inch</i>	<i>mm LXM</i>						<i>Inch</i>	<i>mm LXM</i>										
<i>401</i>	1.5	38x14	420	7.47	3.404	No	<i>485</i>	2.5	61x13	210	15.26	3.396	Yes						
	2	50x15	288	13	3.563	Yes			3	76x16	168	23.14	4.172	No					
	2.5	63x15	210	16	3.686	Yes		<i>502</i>		3.5	13x61	119	33.91	4.44	Yes				
	3	76x18	140	22	3.867	Yes													
<i>405</i>	.8	21x11	880	3.08	2.801	No	<i>504</i>	2.5	62x17	210	17.93	4.372	Yes						
<i>424</i>	2	50x15	288	4	3.489	Yes	<i>504</i>							3	76x18	147	24	4.13	Yes
								3	76x16	168	22.4	3.95	No						
<i>432</i>	.8	21x12	880	2.61	2.592	No	<i>505</i>	2.5	63x15	175	17.17	3.442	Yes						
	1.5	38x12	480	7.4	3.404	Yes			3	76x16	140	23.64	3.7	Yes					
	2	51x14	288	11	3.563	Yes		4		100x26	48	50.93	2.87	Yes					
	2.5	62x15	210	14	3.686	Yes			5	125x27	44	64.02	3.37	Yes					
	3	76x17	140	23	3.867	Yes		6		153x31	32	96.14	3.58	Yes					
	<i>516</i>	3.5	87	102	-	-			Yes										

Packing Details

Bead

<i>Model</i>	<i>Dimensions mm LXM</i>	<i>PCs Per Duplex</i>	<i>Part weight in gms</i>	<i>Duplex weight in gms</i>	<i>Engraved</i>
<i>1502</i>	5.8x6	8820	0.28	3.48	No
	7.8x8	1936	1.6	1.87	No
	9.8x10	1350	2.4	2.25	No
	11.8x12	1400	3.5	3.839	No
	13.3x13.5	840	4.46	3.259	No
	16x16	630	5.2	3.638	No
	18x18	470	9.95	3.71	No
	20x20	260	9.8	3.059	No

Ball

<i>Model</i>	<i>Dimensions mm LXM</i>	<i>PCs Per Duplex</i>	<i>Part weight in gms</i>	<i>Duplex weight in gms</i>	<i>Engraved</i>
<i>702</i>	20	260	14.31	4.22	Yes
	30	90	42.18	4.225	Yes
	40	40	103.06	4.45	Yes
	50	12	193	2.77	Yes
	* 60	4	318	1.7	Yes
	* 70	4	509	2.5	Yes
	100	3	1600	4.164	Yes
<i>710</i>	20	325	7.82	2.35	No
	* 30	90	25	2.405	No
	* 40	40	62	3.083	No
	* 50	24	142	3.715	No
	70	8	386	4	No
	100	3	1292	40.39	No

Packing Details

TR

<i>Model</i>	<i>Dimention mm LXM</i>	<i>PCs Per Duplex</i>	<i>Part weight in gms</i>	<i>Duplex weight in gms</i>	<i>Engraved</i>
<i>TR</i>	100	24	111	3177	-
	150	16	185	3330	-
	180	8	241	2190	-
	200	8	291	2600	-
<i>TR1</i>	100	24	111	3177	-
<i>TR2</i>	100	24	111	3177	-
<i>TR3</i>	100	24	111	3177	-
<i>TR6</i>	100	24	111	3177	-

<i>Model</i>	<i>Dimention mm LXM</i>	<i>PCs Per Duplex</i>	<i>Part weight in gms</i>	<i>Duplex weight in gms</i>	<i>Engraved</i>
<i>TR7</i>	100	24	111	3177	-
<i>TR8</i>	100	24	111	3177	-
<i>TR9</i>	100	24	111	3177	-
<i>TR10</i>	100	24	111	3177	-
<i>TR11</i>	100	24	111	3177	-
<i>TR12</i>	100	24	111	3177	-

Packing Details

Arm

<i>Model</i>	<i>Dimensions mm LXM</i>	<i>PCs Per Duplex</i>	<i>Part weight in gms</i>	<i>Duplex weight in gms</i>	<i>Engraved</i>	<i>Model</i>	<i>Dimensions mm LXM</i>	<i>PCs Per Duplex</i>	<i>Part weight in gms</i>	<i>Duplex weight in gms</i>	<i>Engraved</i>	
<i>Arm 1</i>	150	-	40	136	No	<i>Arm 5</i>	150	-	40	160	No	
	200	-	40	174	No		200	-	40	255	No	
	250	-	64	184	No		250	-	64	280	No	
	300	-	40	197	No							
	360	-	40	255	No							
<i>Arm 2</i>	150	-	40	205	No	<i>Arm 6</i>	200	-	40	152	No	
	180	-	40	237	No							
	250	-	64	270	No							
	300	-	40	428	No							
<i>Arm 3</i>	200	-	40	147	No	<i>Arm 21</i>	240	-	64	263	No	
	300	-	20	273	No							
<i>Arm 4</i>	200	-	40	152	No	<i>Arm 22</i>	360	-	32	366	No	
						<i>Arm 23</i>	150	-	64	175	No	

Packing Details

Bobech

<i>Model</i>	<i>Dimensions mm LXM</i>	<i>PCs Per Carton</i>	<i>Part weight in gms</i>	<i>Engraved</i>
<i>Art 100</i>	87x87	108	216	No
<i>Art 101</i>	85 100	140 99	100 142	No No
<i>Art 102</i>	110	88	254	No
<i>Art 103</i>	100 120 150 200 250 300 350	99 64 60 10 10 1 1	142 205 393 0 1685 2975 -	No No No No No No No

<i>Model</i>	<i>Dimensions mm LXM</i>	<i>PCs Per Carton</i>	<i>Part weight in gms</i>	<i>Engraved</i>
<i>Art 104</i>	140	28	532	No
<i>Art 105</i>	150	60	372	No
			Available in hole diameters from 10 mm : 42 mm	
<i>Art 106</i>	140	60	372	No
			Available in hole diameters from 10 mm : 42 mm	
<i>Art 1036</i>	100	9	225	No
			Available in hole diameters from 10 mm : 42 mm	
<i>Art 1038</i>	100	9	212	No
			Available in hole diameters from 10 mm : 42 mm	
<i>Art 107</i>	104	24	-	No

Packing Details

Center Piece

<i>Model</i>	<i>Dimentions mm LXM</i>	<i>PCs Per Duplex</i>	<i>Part weight in gms</i>	<i>Duplex weight in gms</i>	<i>Engraved</i>
<i>Center Piece 1</i>	170	12	-	-	No
	150	12	-	-	No
	130	15	-	-	No
<i>Center Piece 2</i>	90	20	-	-	No
	140	16	-	-	No
<i>Center Piece 3</i>	168	24	-	-	No
<i>Center Piece 4</i>	100	32	-	-	No

<i>Model</i>	<i>Dimentions mm LXM</i>	<i>PCs Per Duplex</i>	<i>Part weight in gms</i>	<i>Duplex weight in gms</i>	<i>Engraved</i>
<i>Center Piece 5</i>	80	24	-	-	No
	165	32	-	-	No
<i>Center Piece 6</i>	76	24	-	-	No
<i>Center Piece 7</i>	165	24	-	-	No

Rosita

<i>Model</i>	<i>Dimentions mm LXM</i>	<i>PCs Per Duplex</i>	<i>Part weight in gms</i>	<i>Duplex weight in gms</i>	<i>Engraved</i>
<i>1006</i>	14	1750	1.8	3.897	No
	20	715	3.4	3.061	No
	24	728	5.0	4.147	No
	30	330	8.0	3.157	No

Packing Details

<i>Model</i>	<i>PCs Per Box</i>
<i>Sky Light</i>	10
<i>Feather</i>	4
<i>Hover</i>	4
<i>Galaxy</i>	14 6 Doublex in Carton
<i>Leaves</i>	20
<i>Spiral Leaves</i>	12

<i>Model</i>	<i>PCs Per Box</i>
<i>Evergreen</i>	Customized
<i>Flutters</i> Customized Box	1
<i>Fiona</i>	10 in Carton
<i>Tree Light</i>	10 in Carton
<i>Crystal Cookies</i>	Customized

The Crystal Breeze parts packaging are customizable
Ask our Team For Details

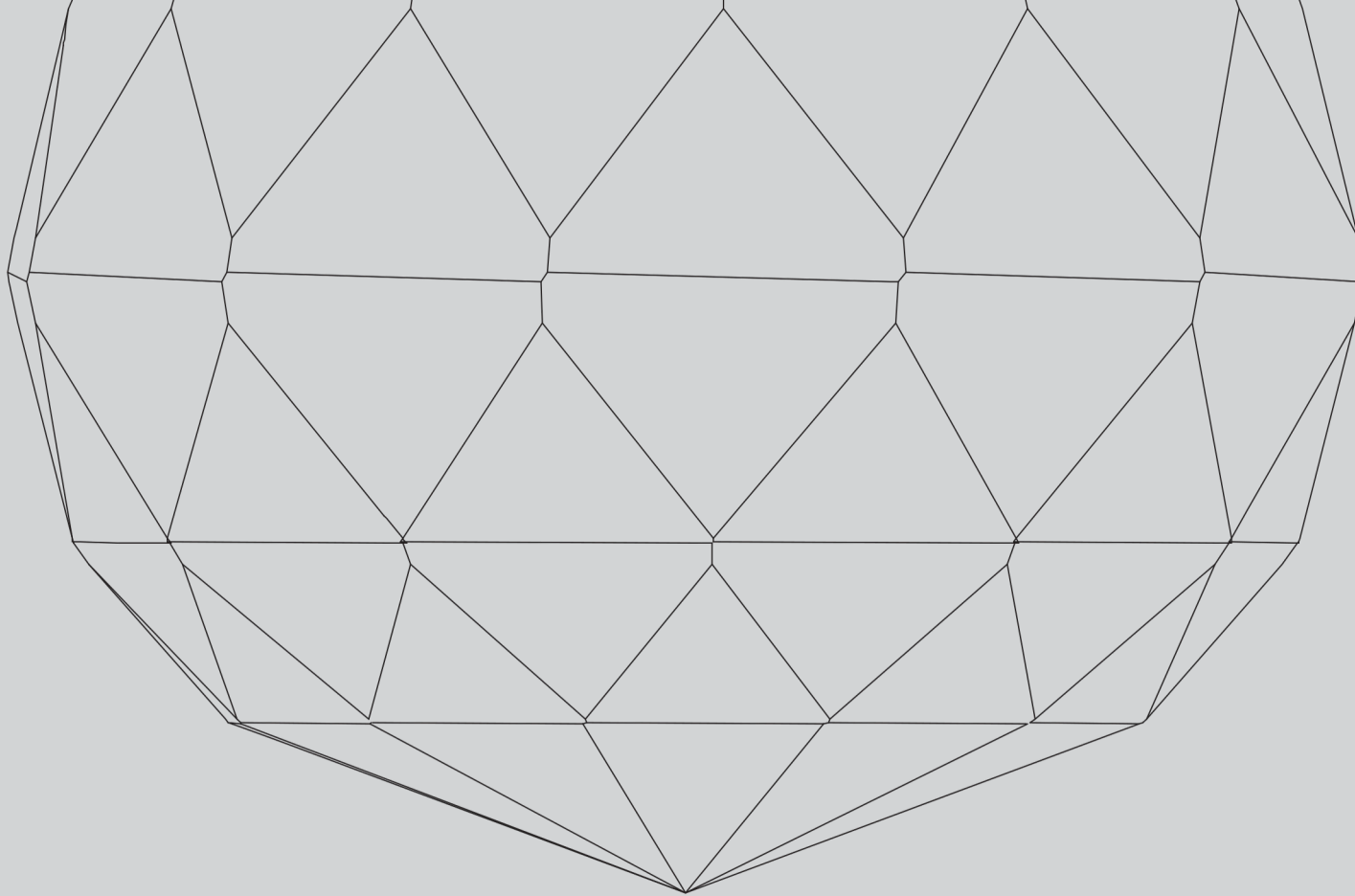

ASFOUR
CRYSTAL

www.asfourcrystalqatar.com

Info@asfourcrystalqatar.com

Asfour crystal st

salwa street , barwa village